

[Click on your shoe size and print labeled pages](#)

visit our **Customizing Page** for more information on the perfect fit and style for you

page 2 explains using the OESH Create Sole for the alpargata pattern

size 5, pages 3-6

size 6, pages 7-10

size 7, pages 11-14

size 8, pages 15-18

size 9, pages 19-22

size 10, pages 23-26

size 11, pages 27-30

size 12, pages 31-34

size 13, pages 35-38

[Enjoy making your OESH Creates!](#)

Please share your experience on our **Community Forum**



start **and** end here →

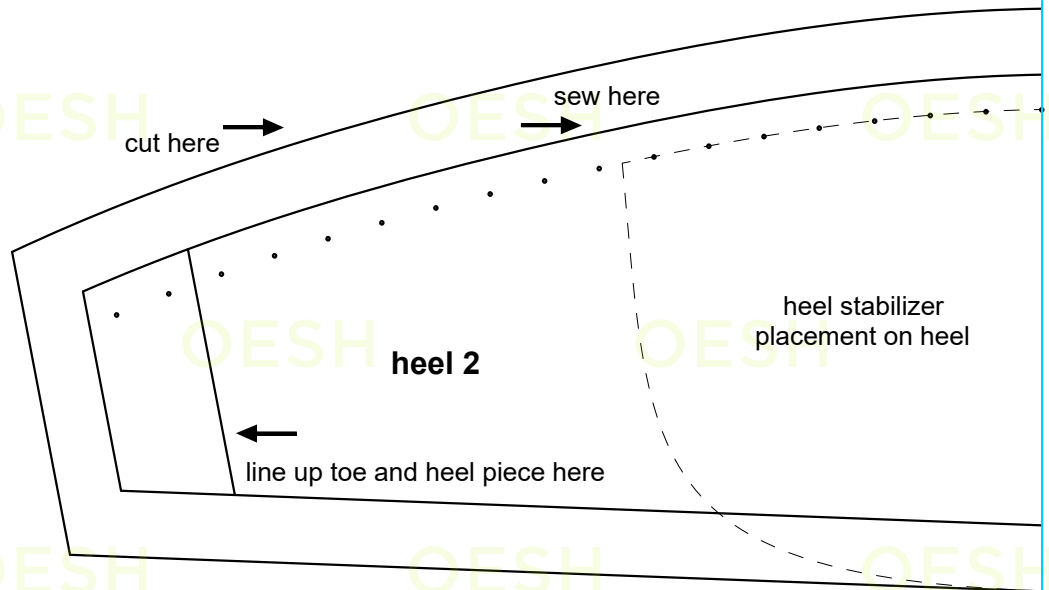
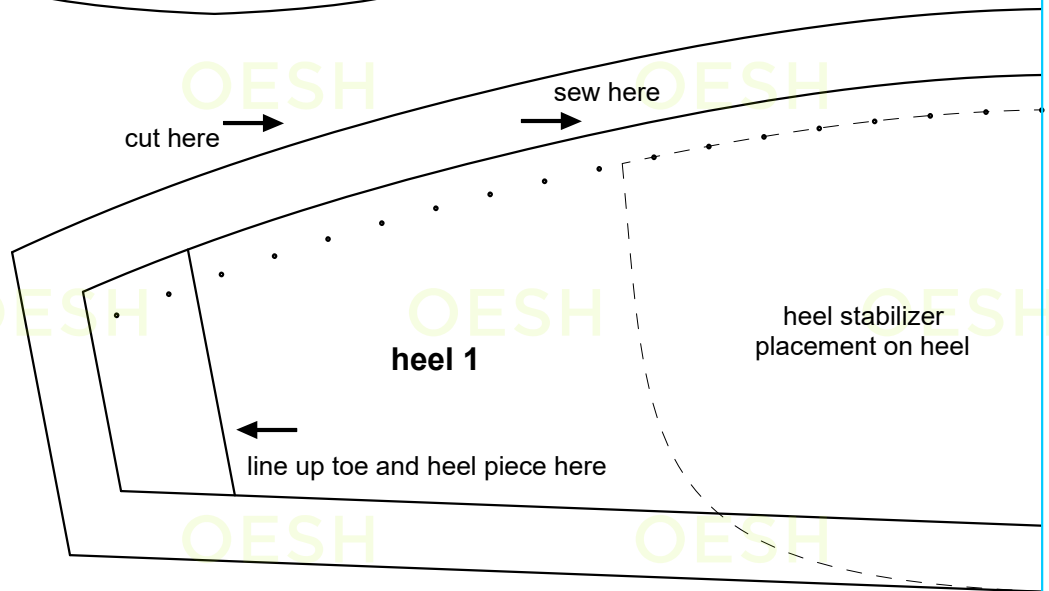
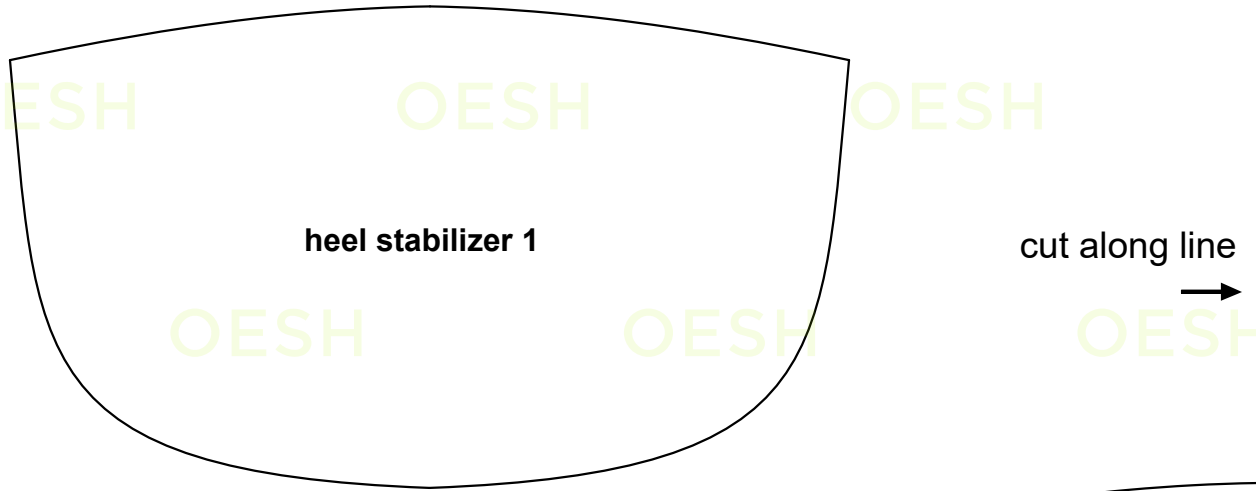

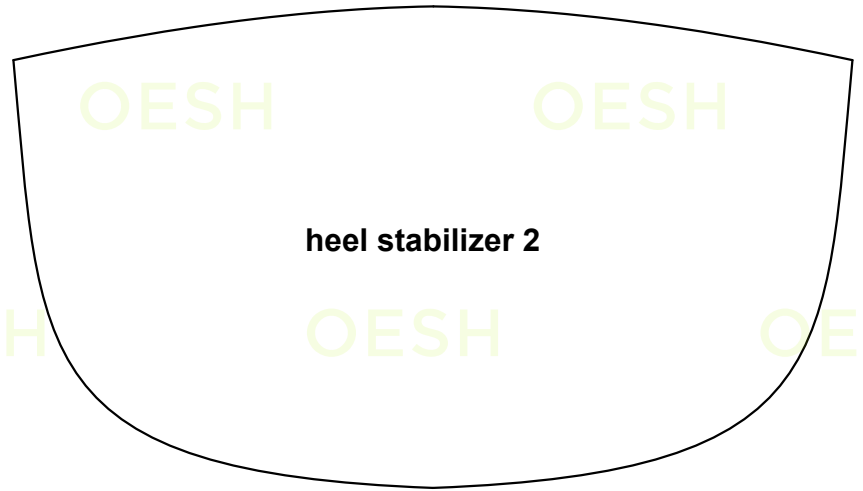

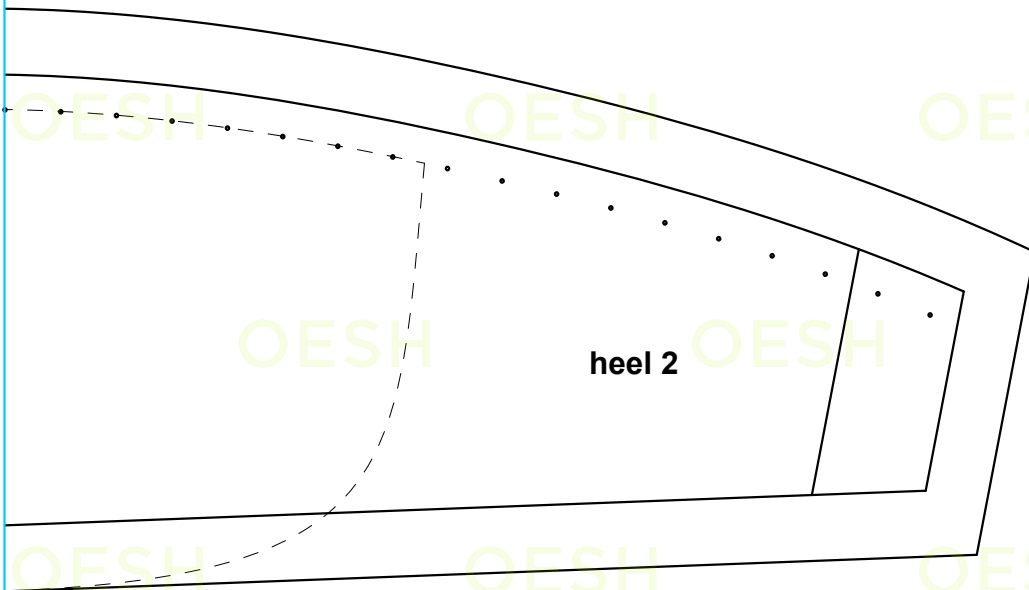
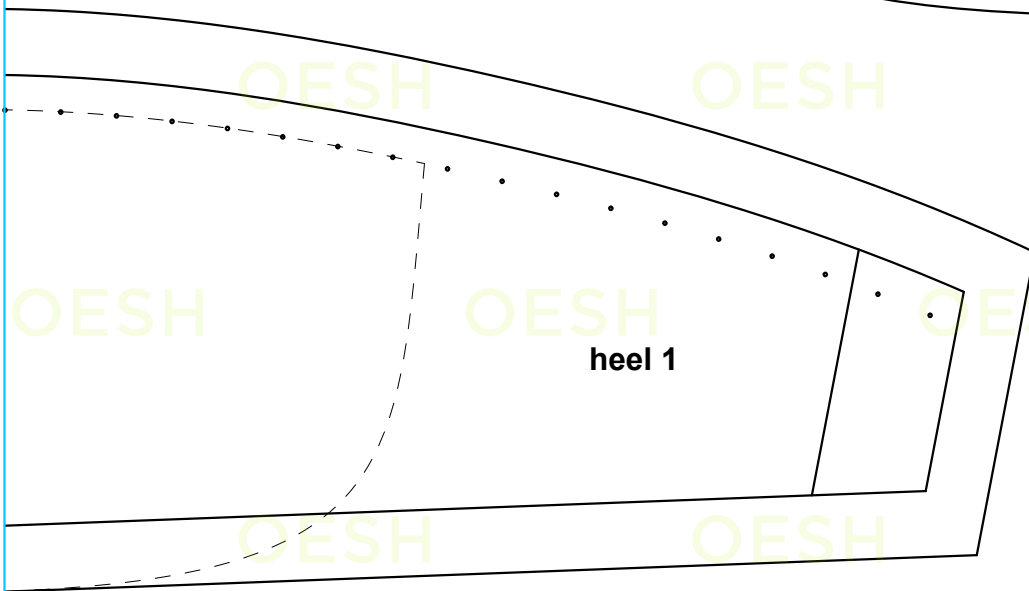

attach pages along line

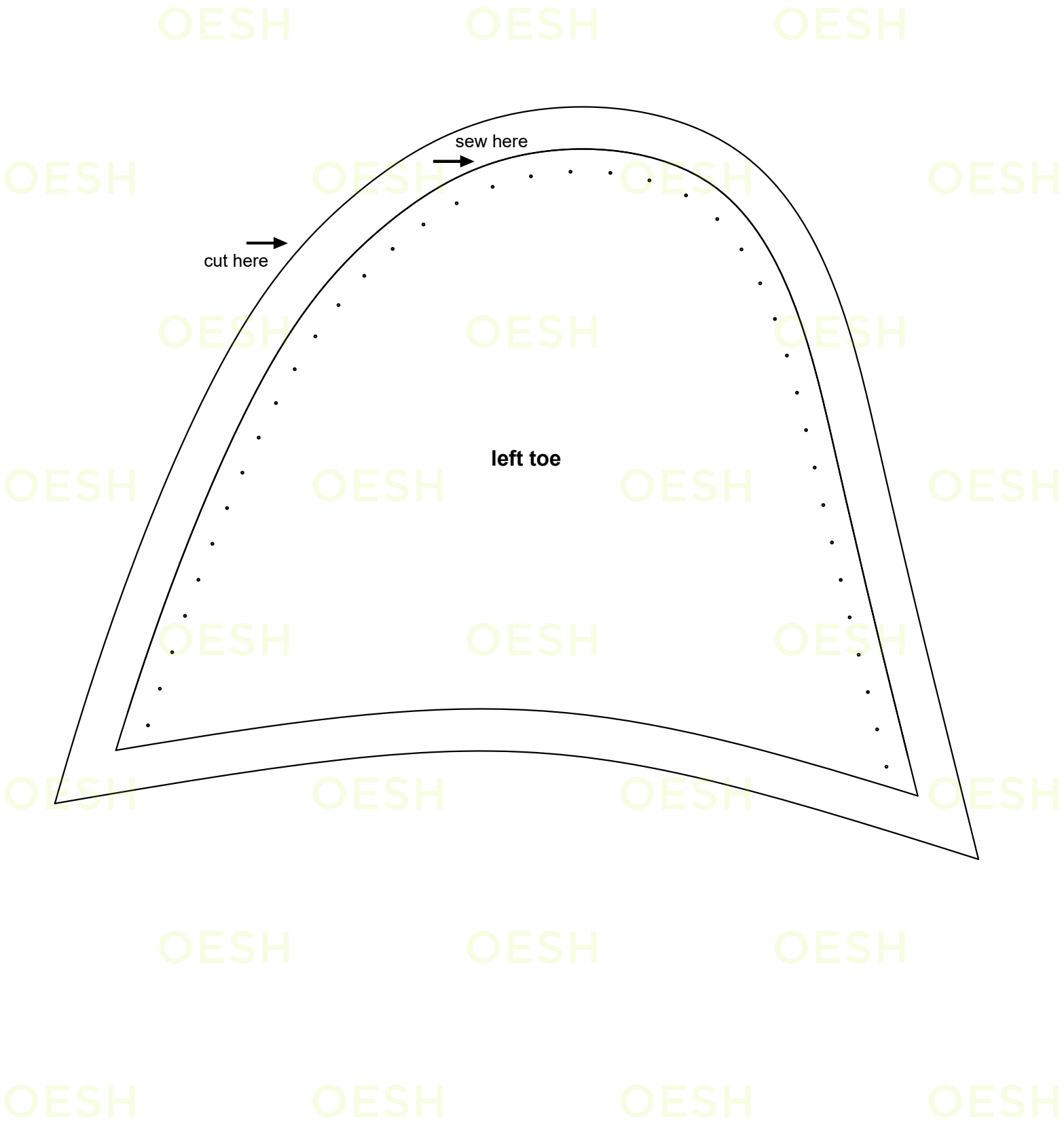



OESH OESH OESH

OESH OESH OESH OESH

cut here  sew here 

right toe

OESH OESH OESH OESH

OESH OESH OESH OESH

OESH OESH OESH OESH

OESH OESH OESH

OESH OESH OESH OESH

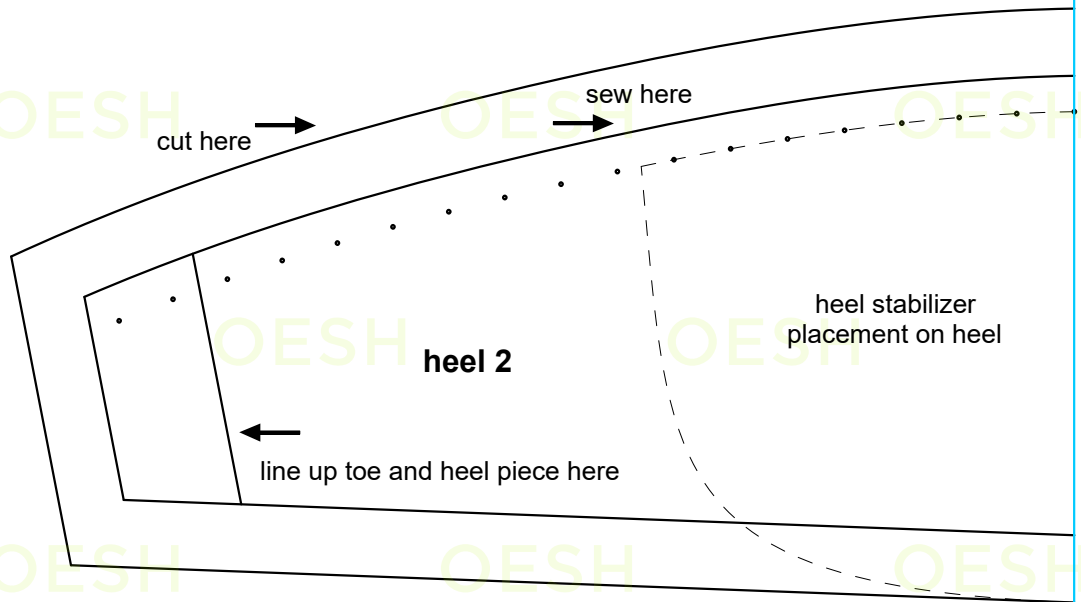
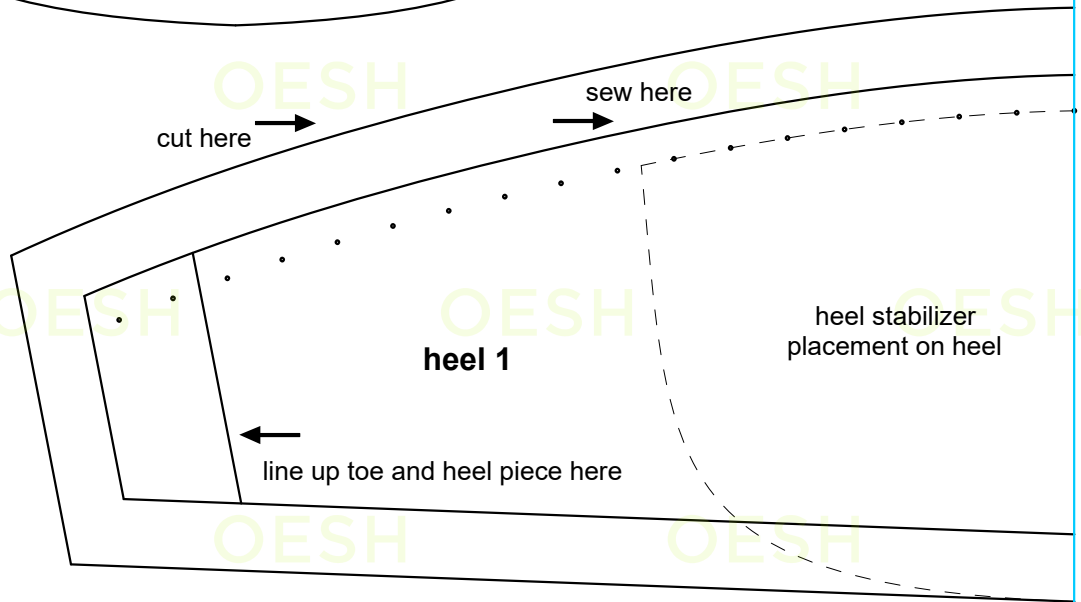
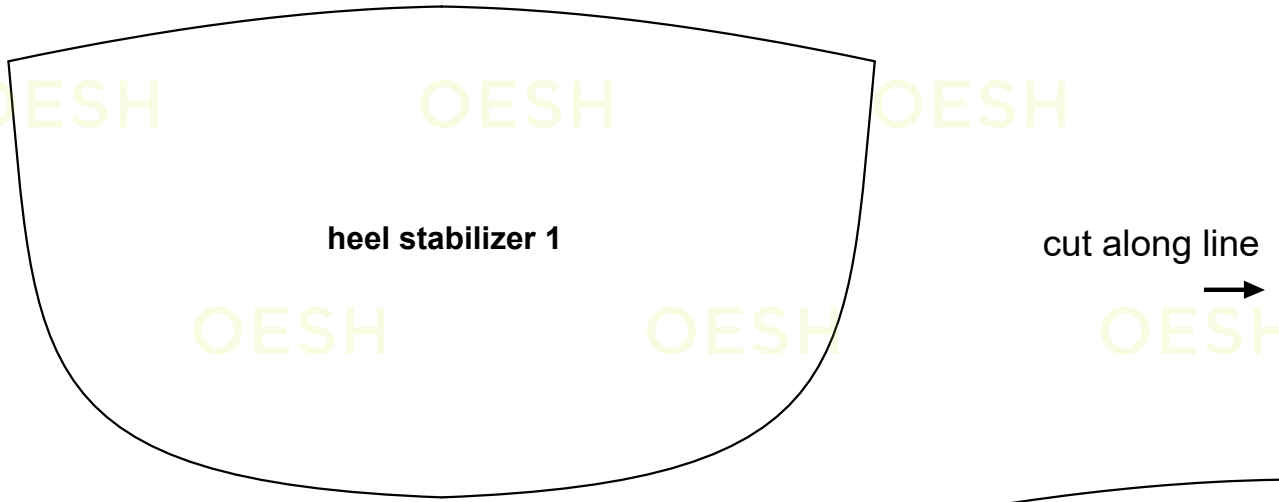

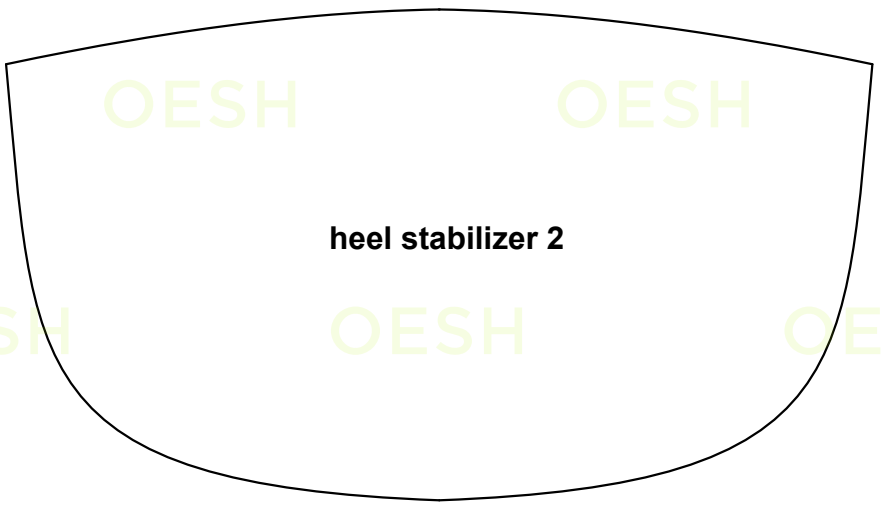

attach pages along line

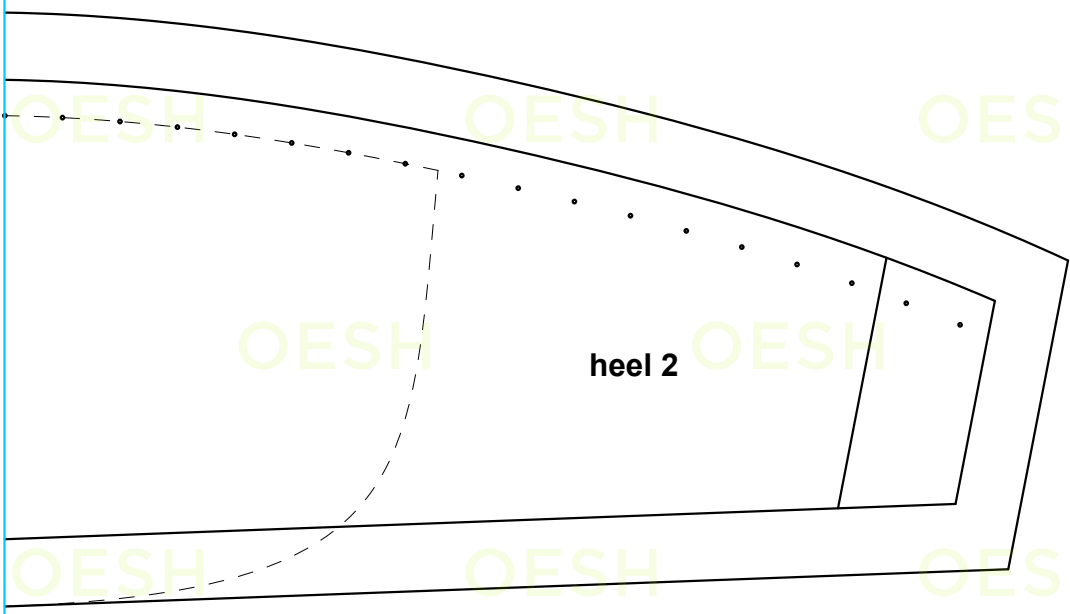
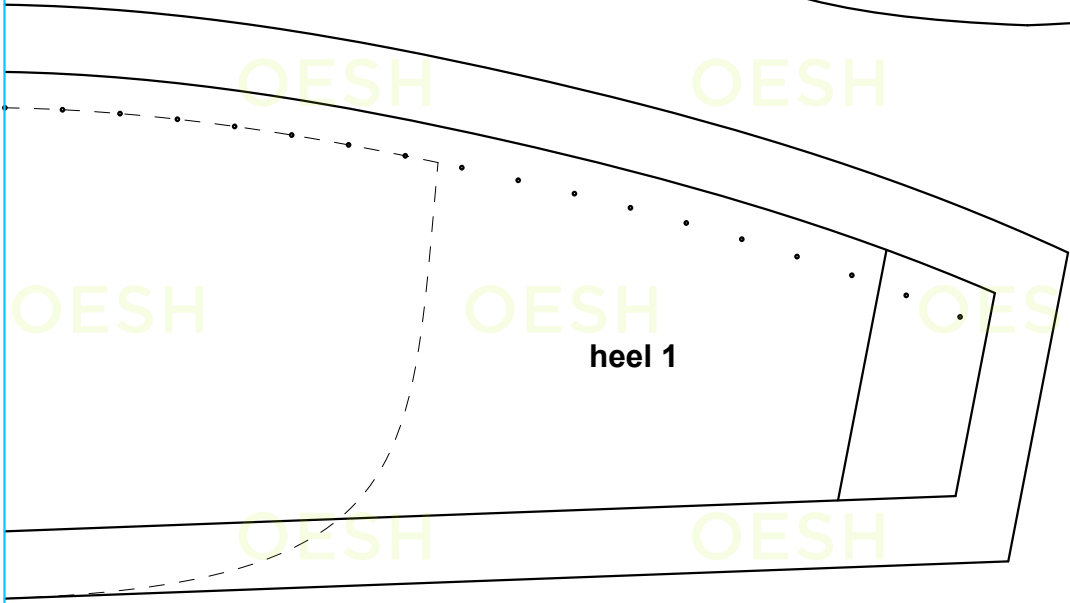

OESH

OESH

OESH

OESH

OESH

OESH

OESH

OESH

OESH

OESH

OESH

OESH

OESH

OESH

OESH

OESH

OESH

OESH

OESH

OESH

OESH

OESH

OESH

OESH

OESH

OESH

OESH

OESH

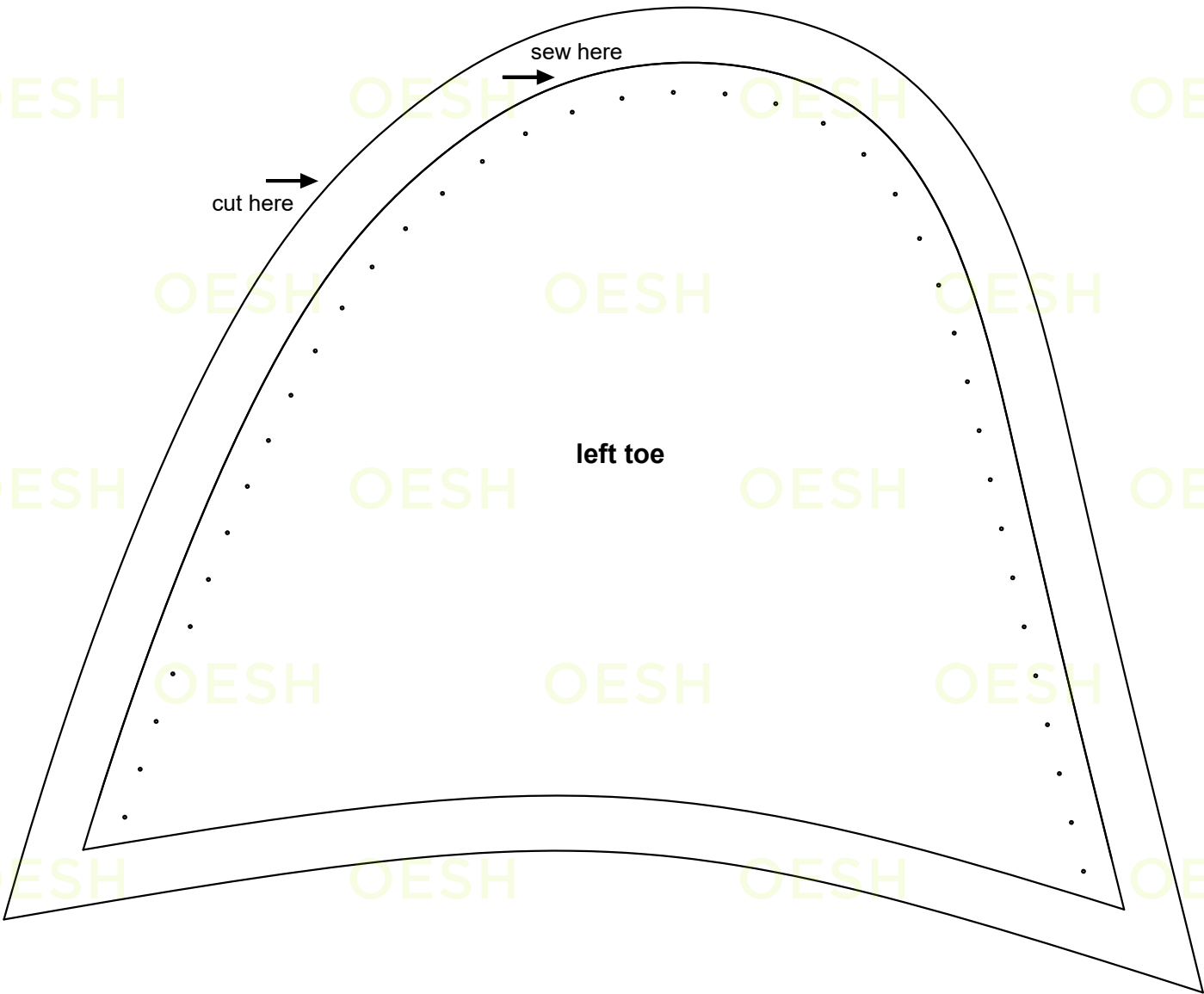

OESH OESH OESH

OESH OESH OESH OESH

cut here →

← sew here

OESH OESH OESH

OESH OESH OESH OESH

right toe

OESH OESH OESH

OESH OESH OESH OESH

OESH OESH OESH

OESH OESH OESH OESH

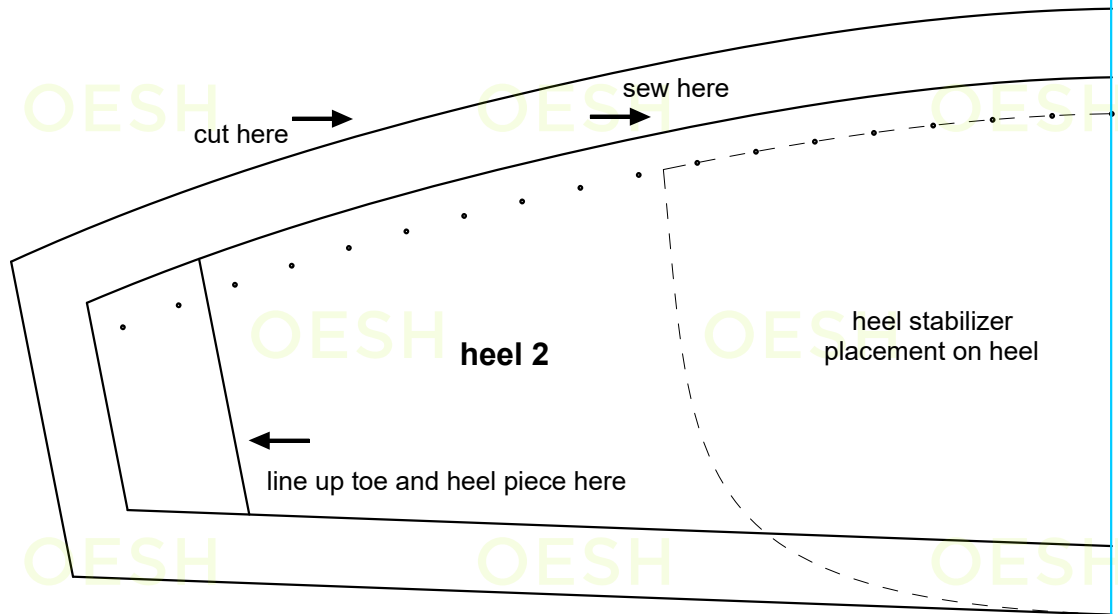
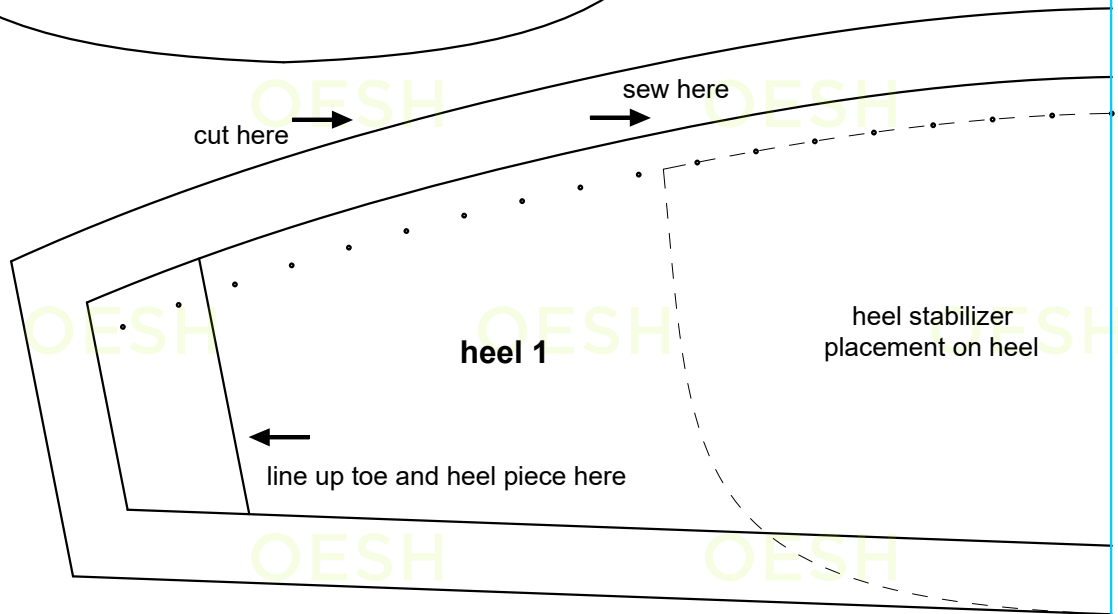
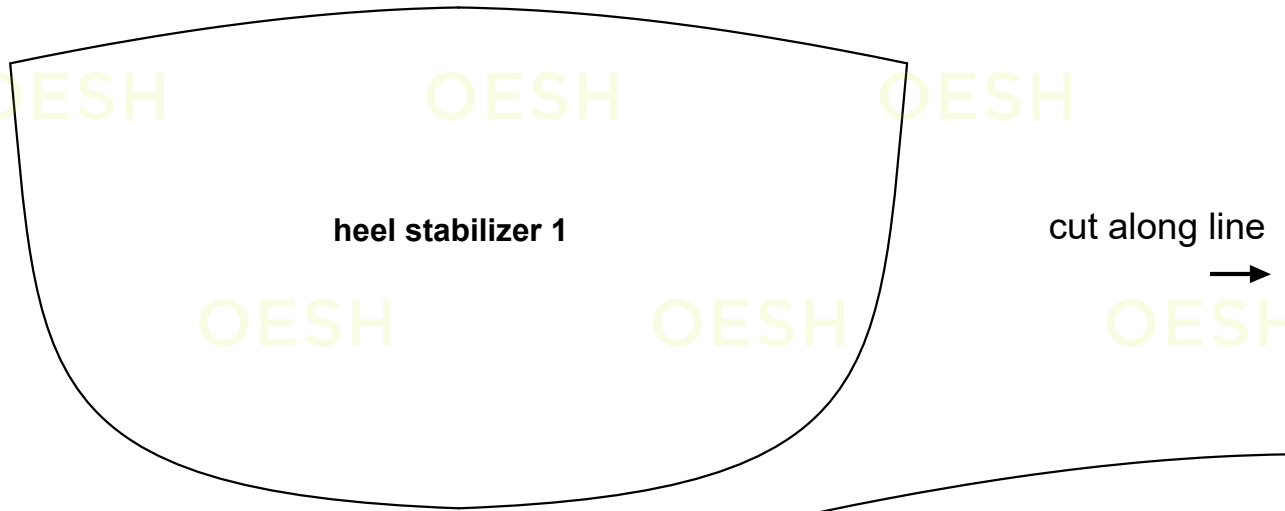

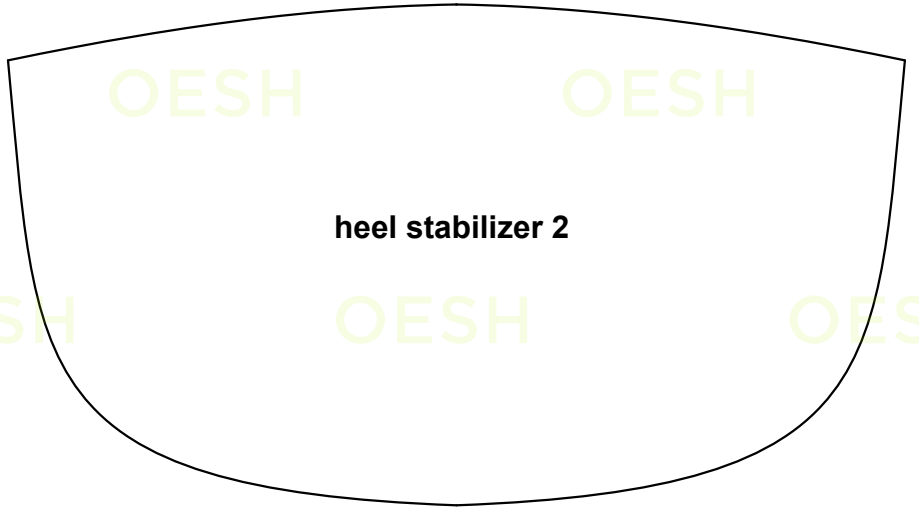

attach pages along line

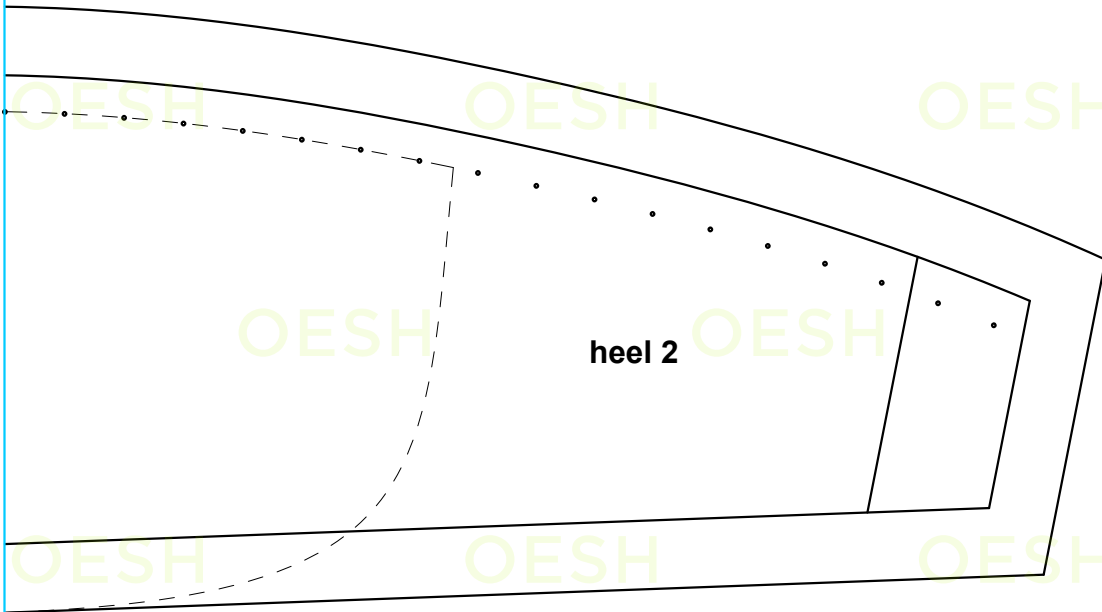
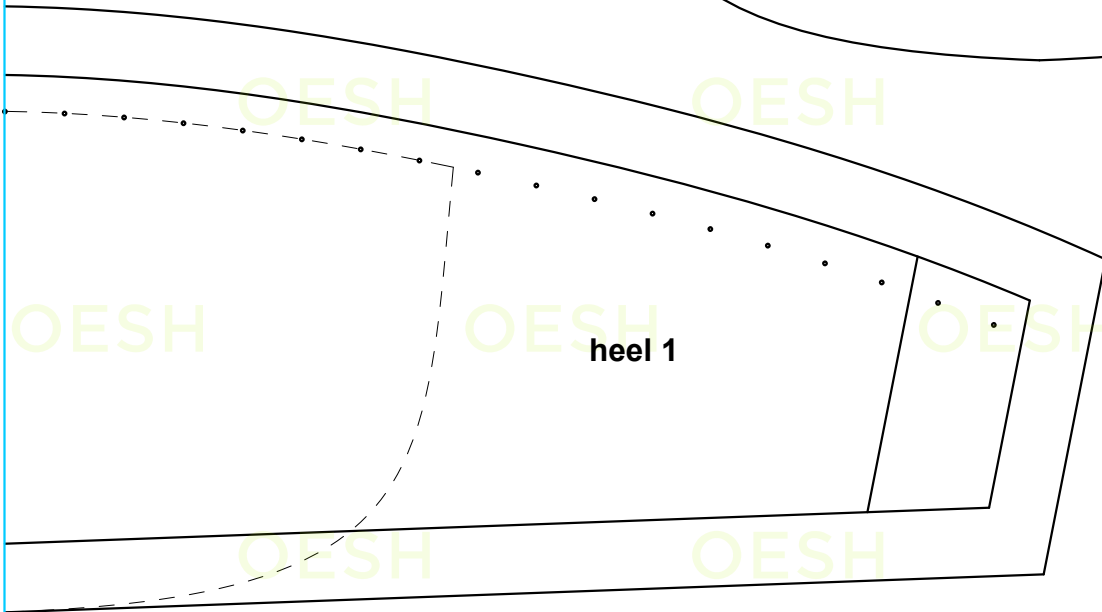

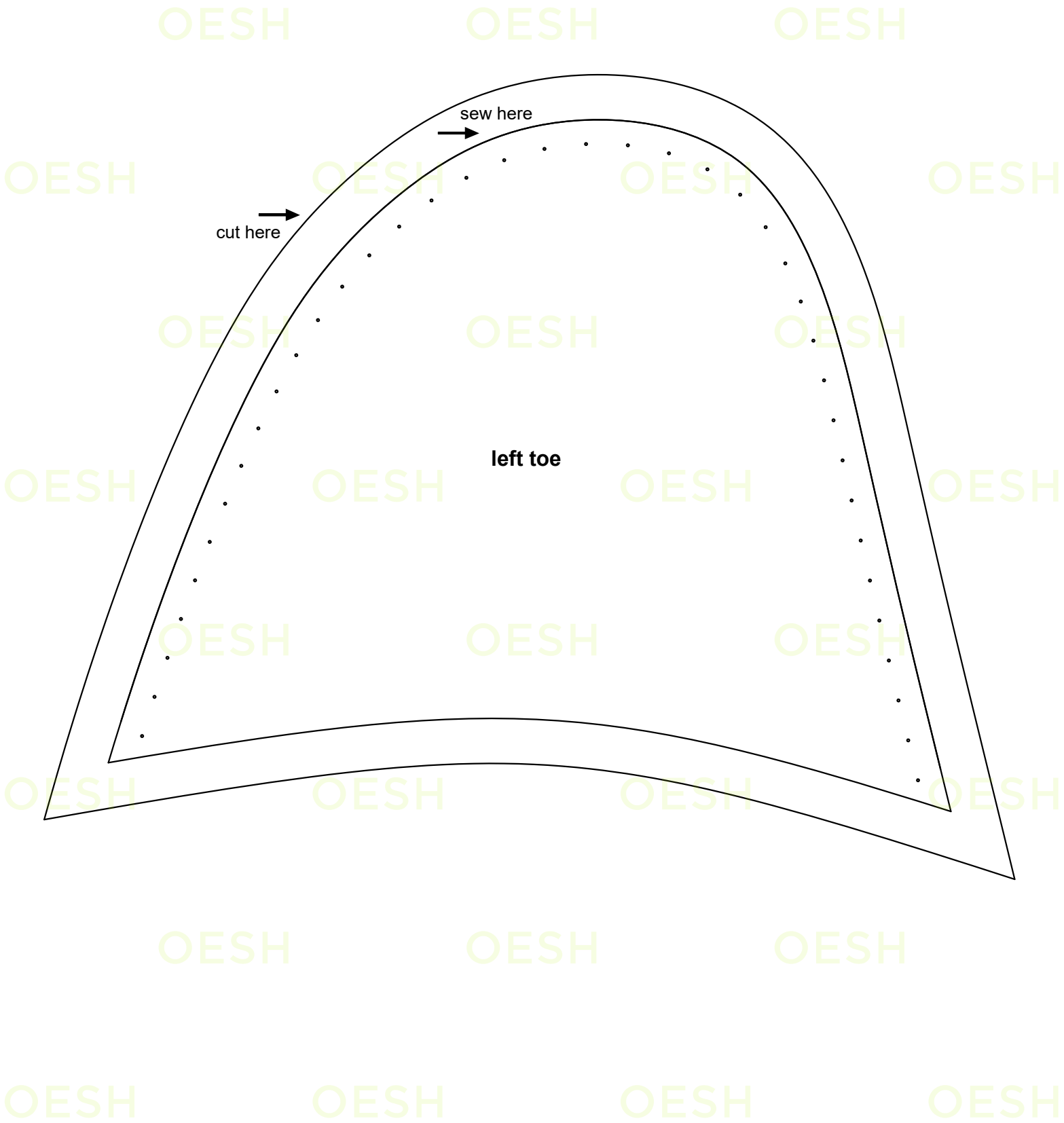

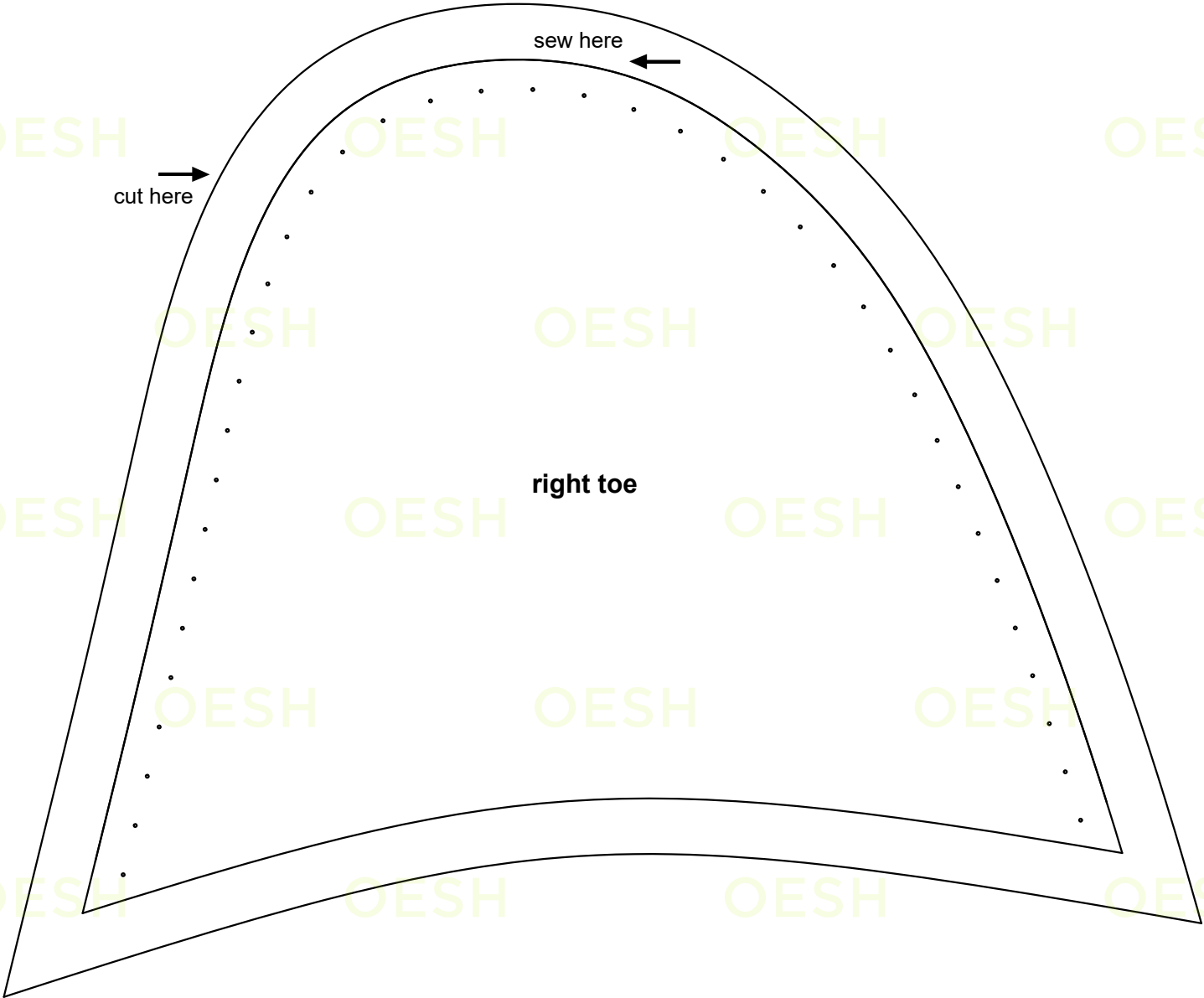

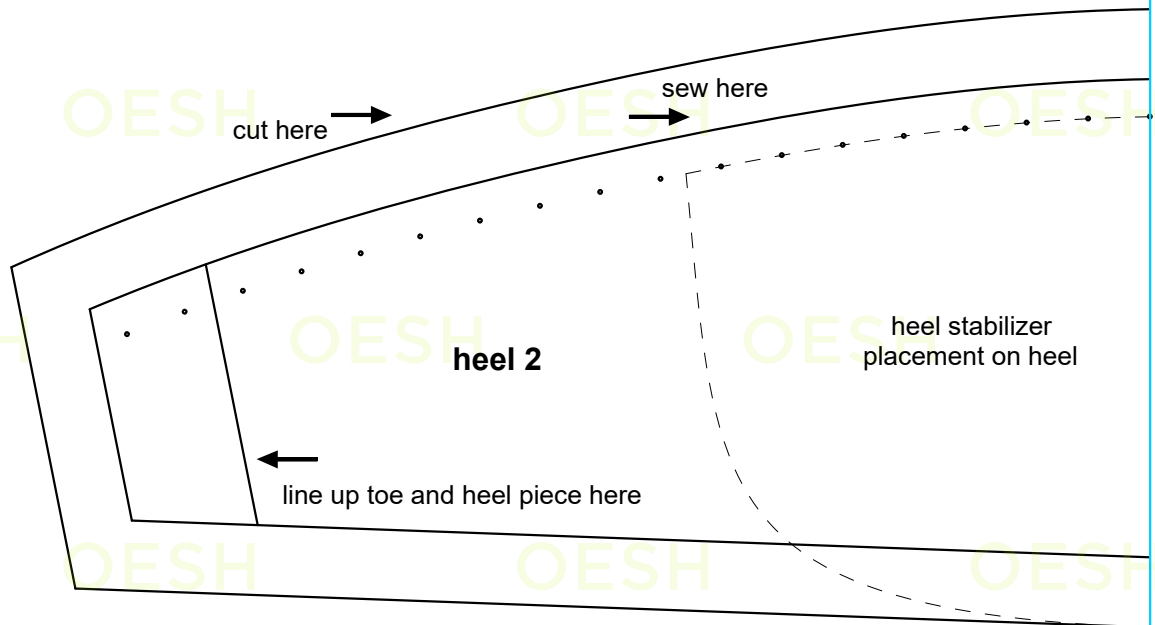
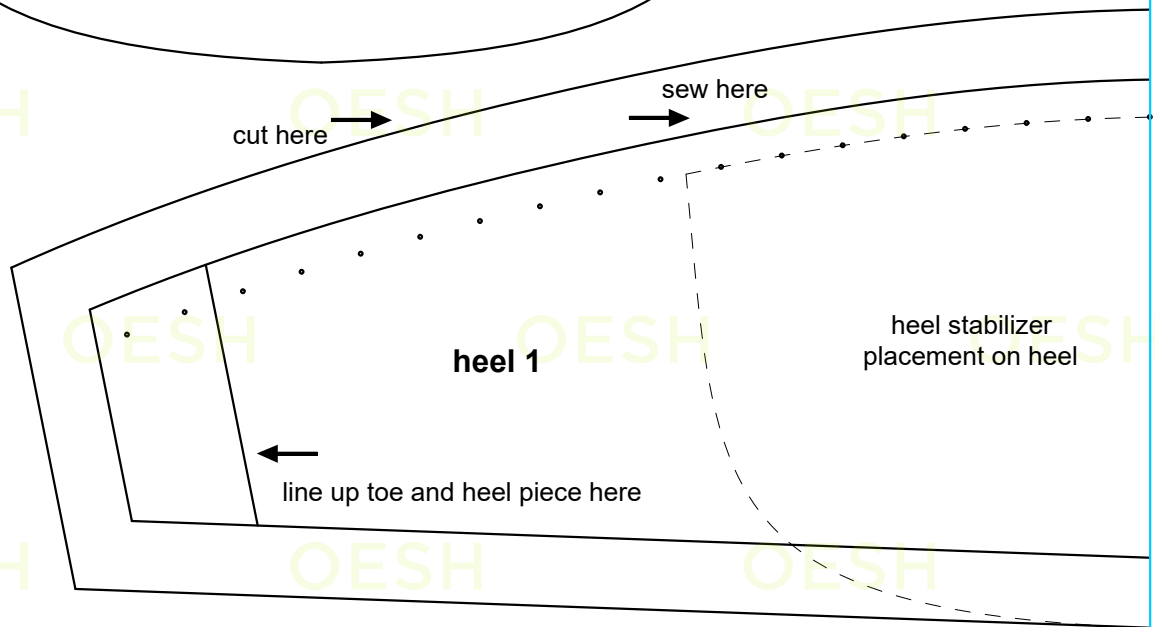
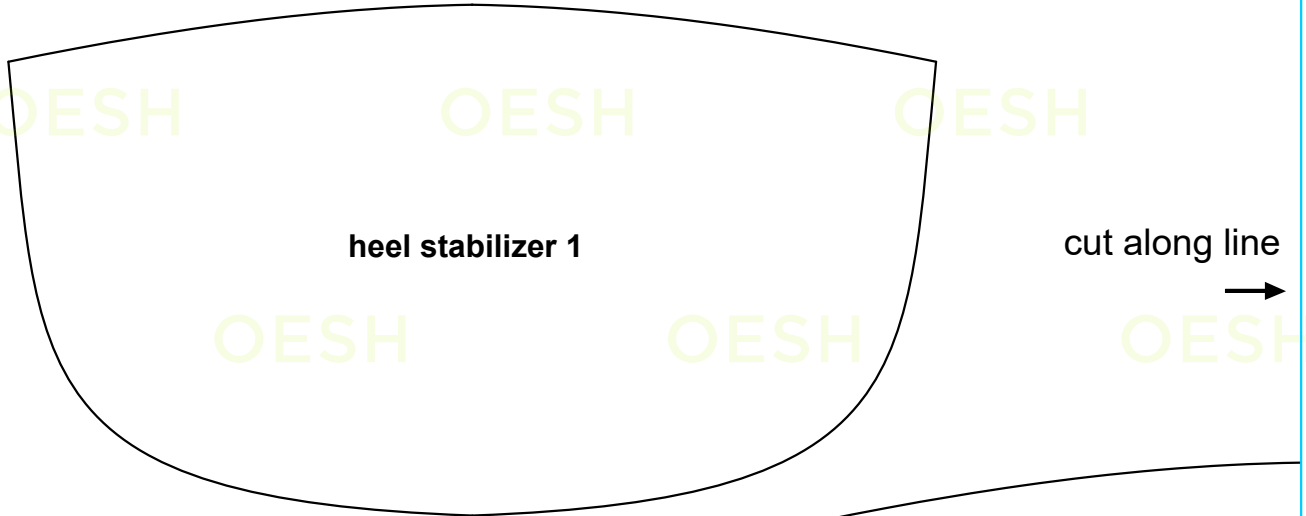

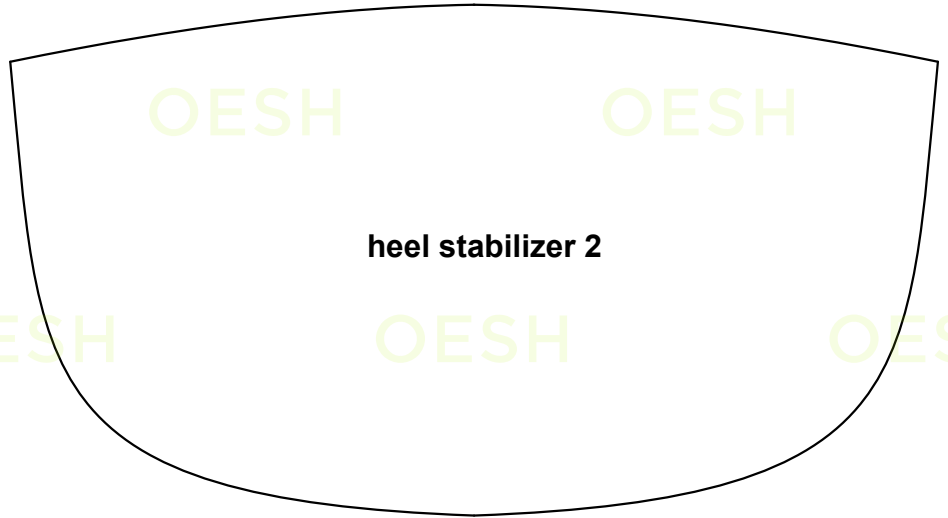

attach pages along line

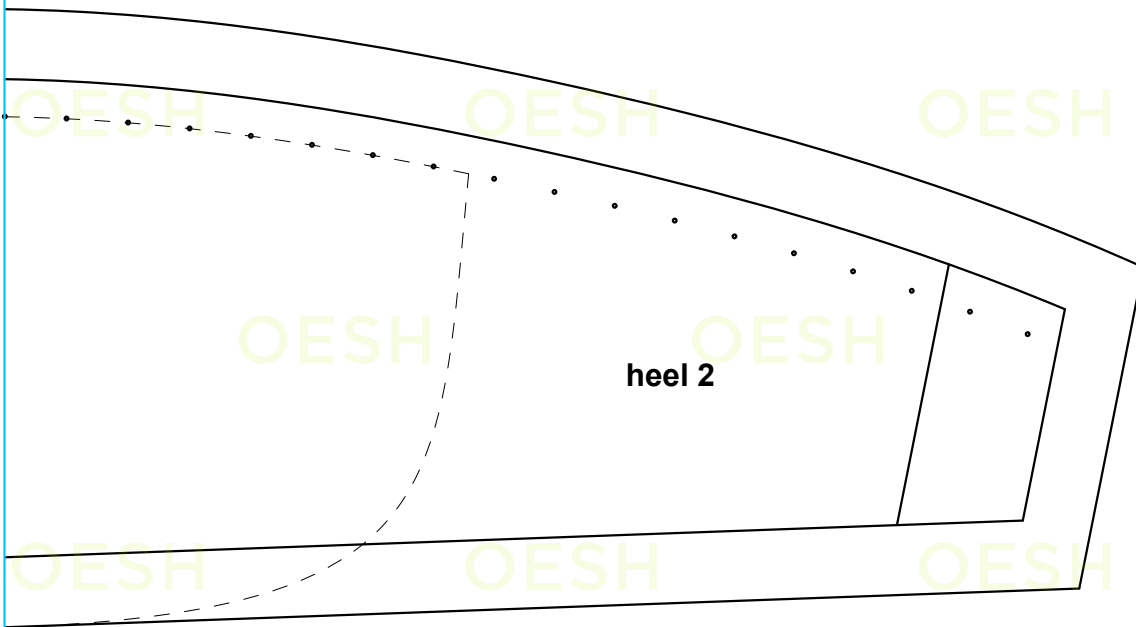
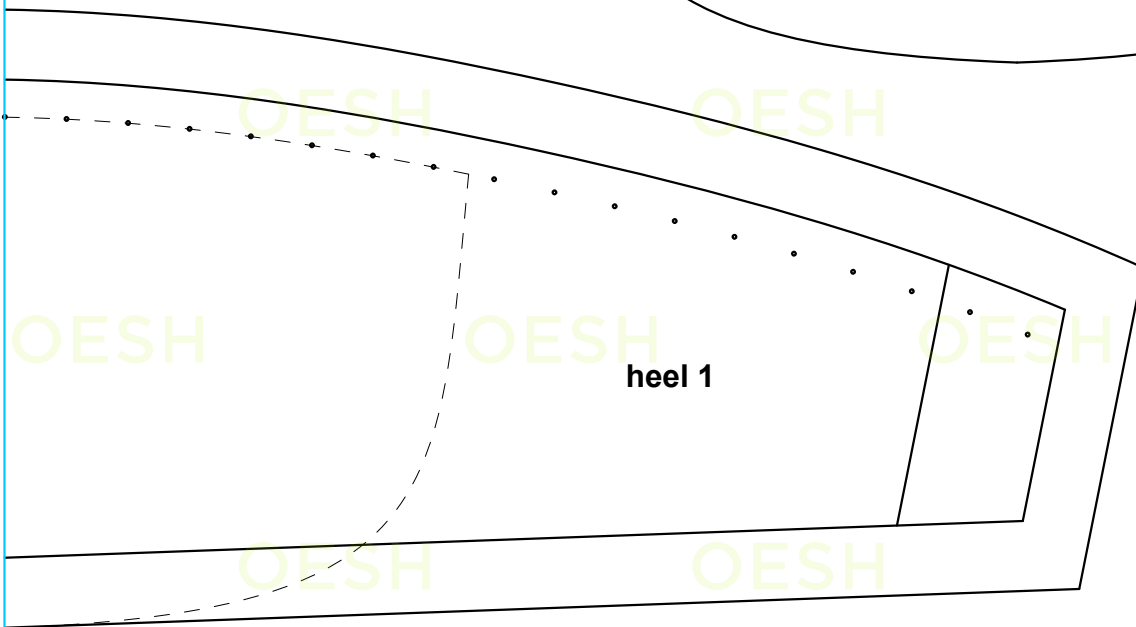

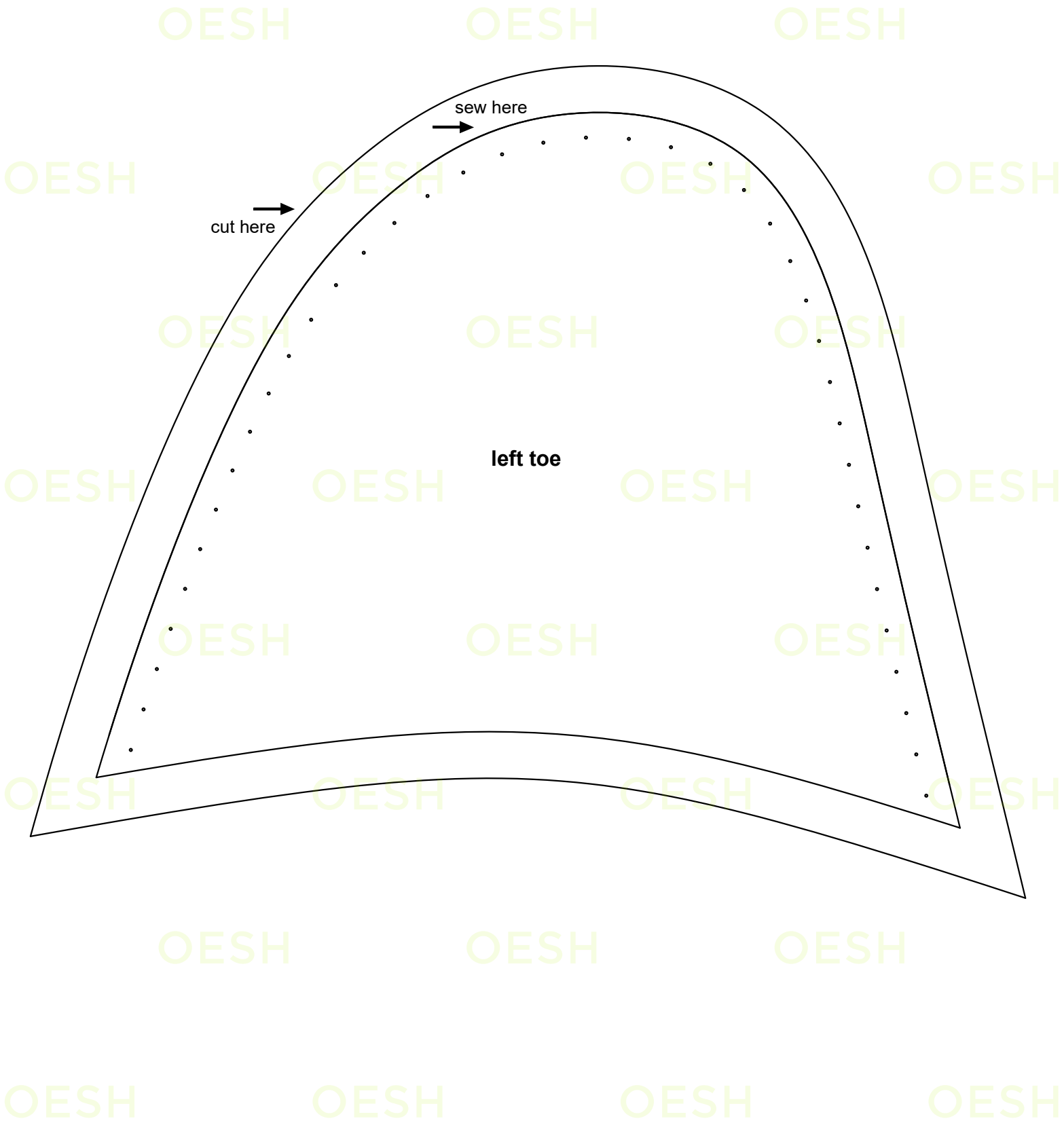

OESH

OESH

OESH

OESH

OESH

OESH

OESH

cut here

sew here

OESH

OESH

OESH

OESH

OESH

right toe

OESH

OESH

OESH

OESH

OESH

OESH

OESH

OESH

OESH

OESH

OESH

OESH

OESH

OESH

OESH

OESH

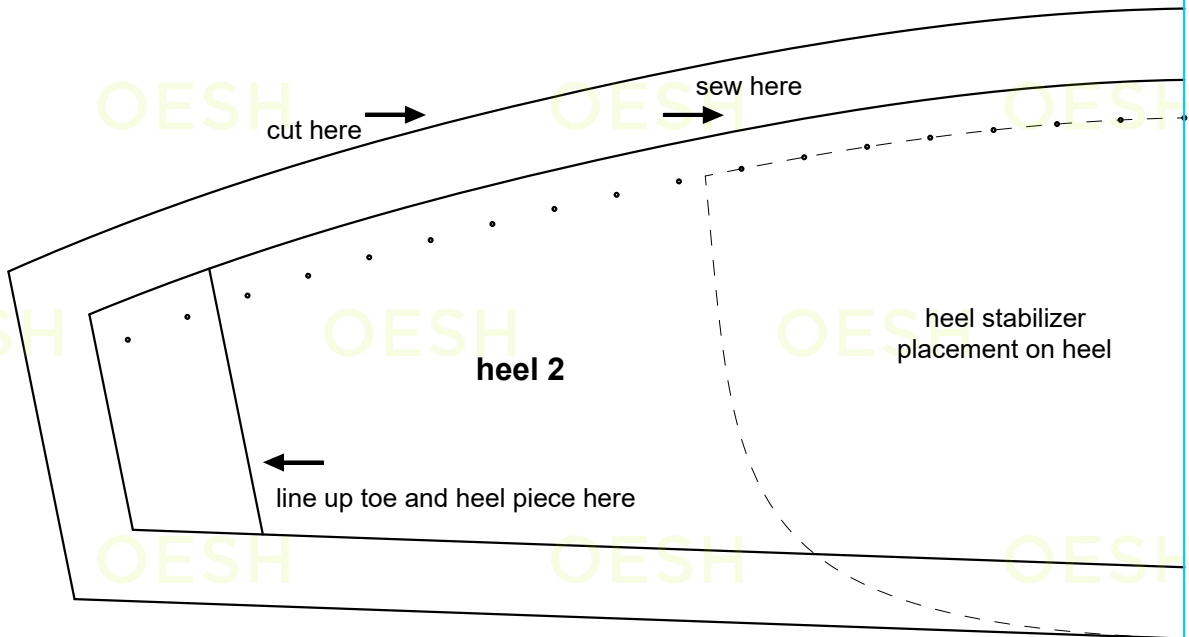
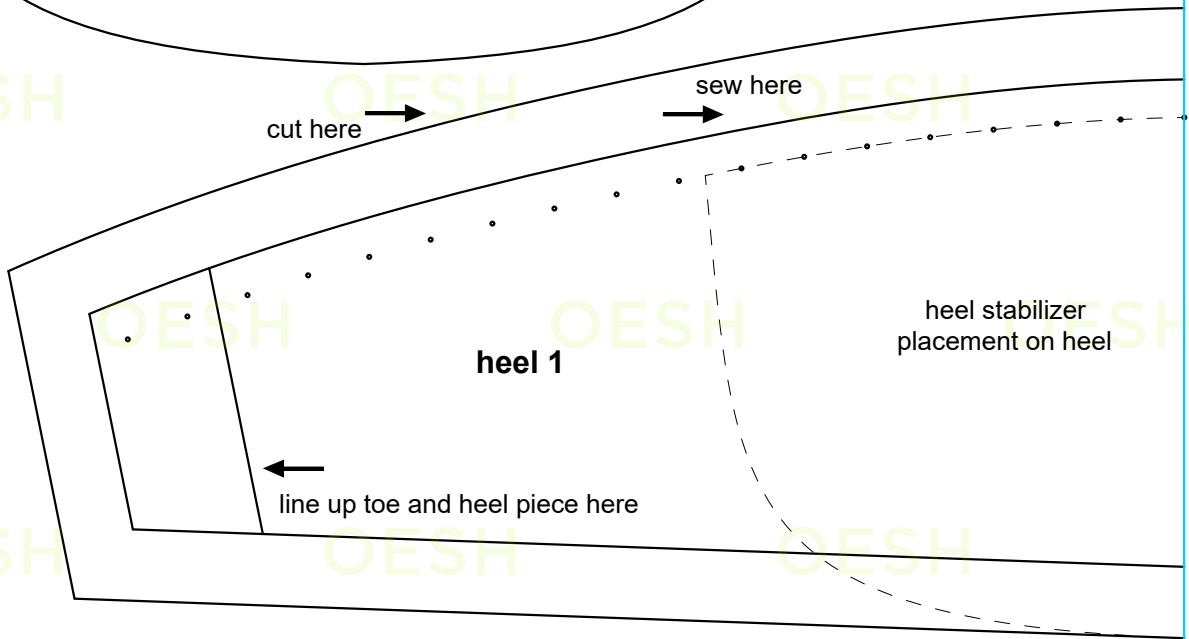
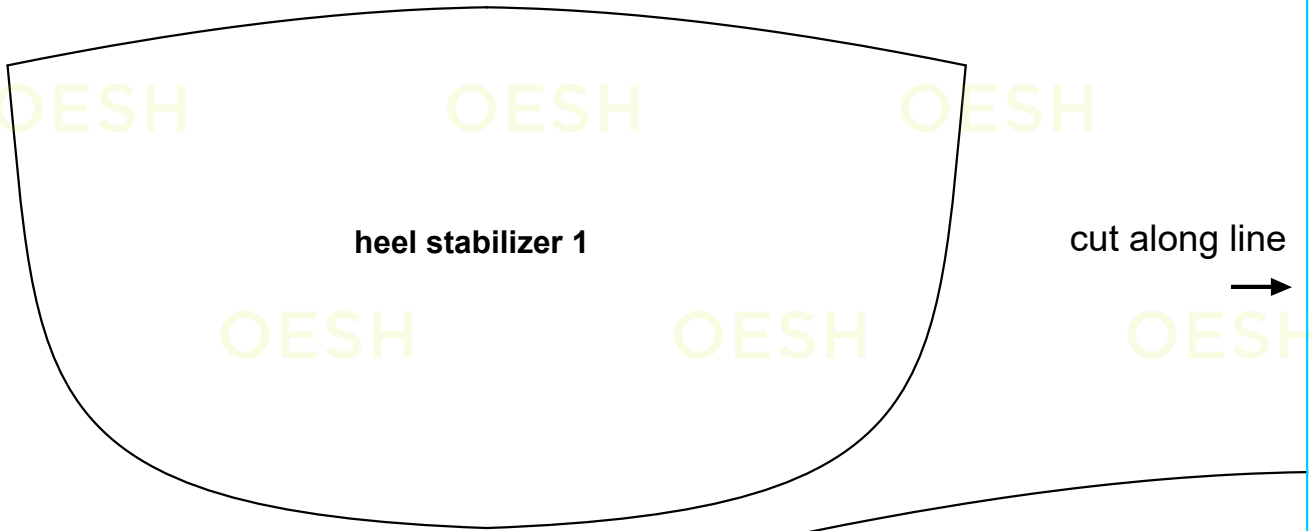

attach pages along line

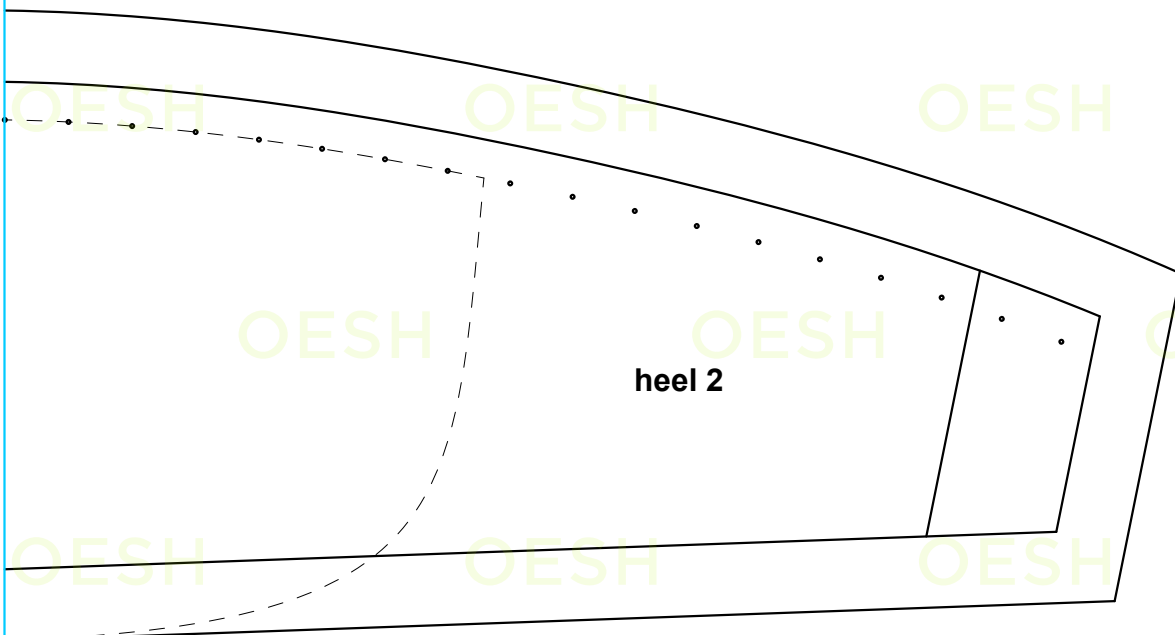
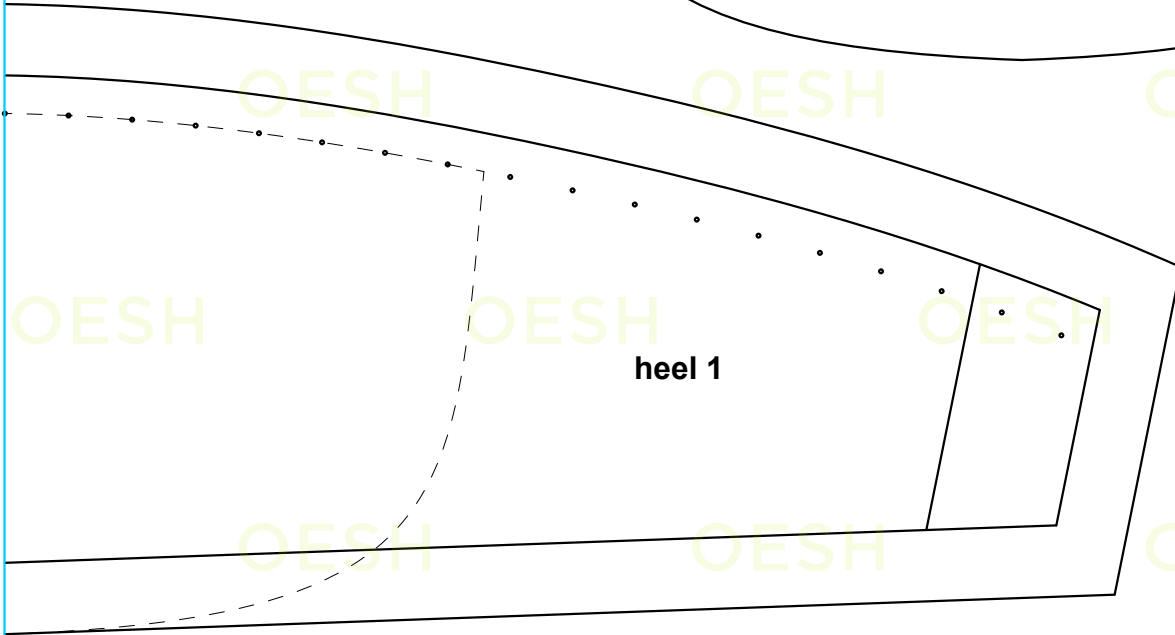
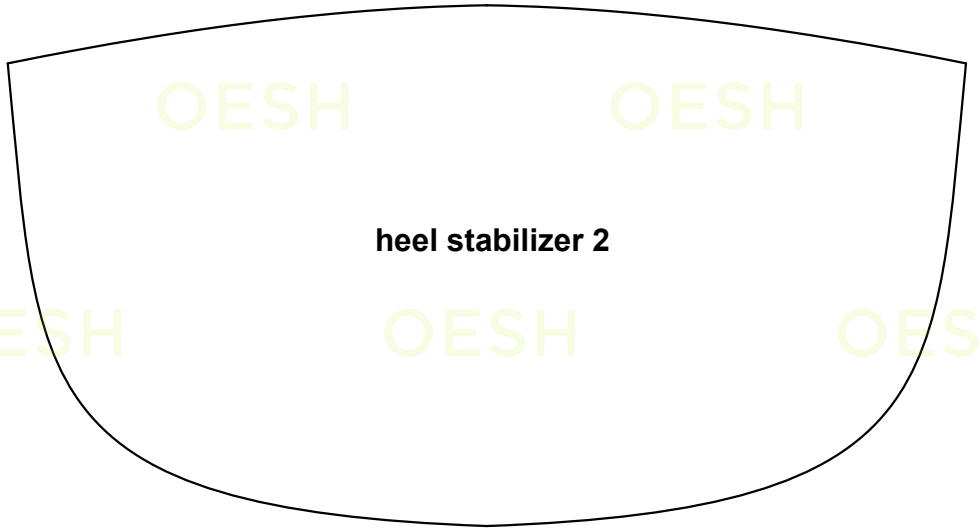

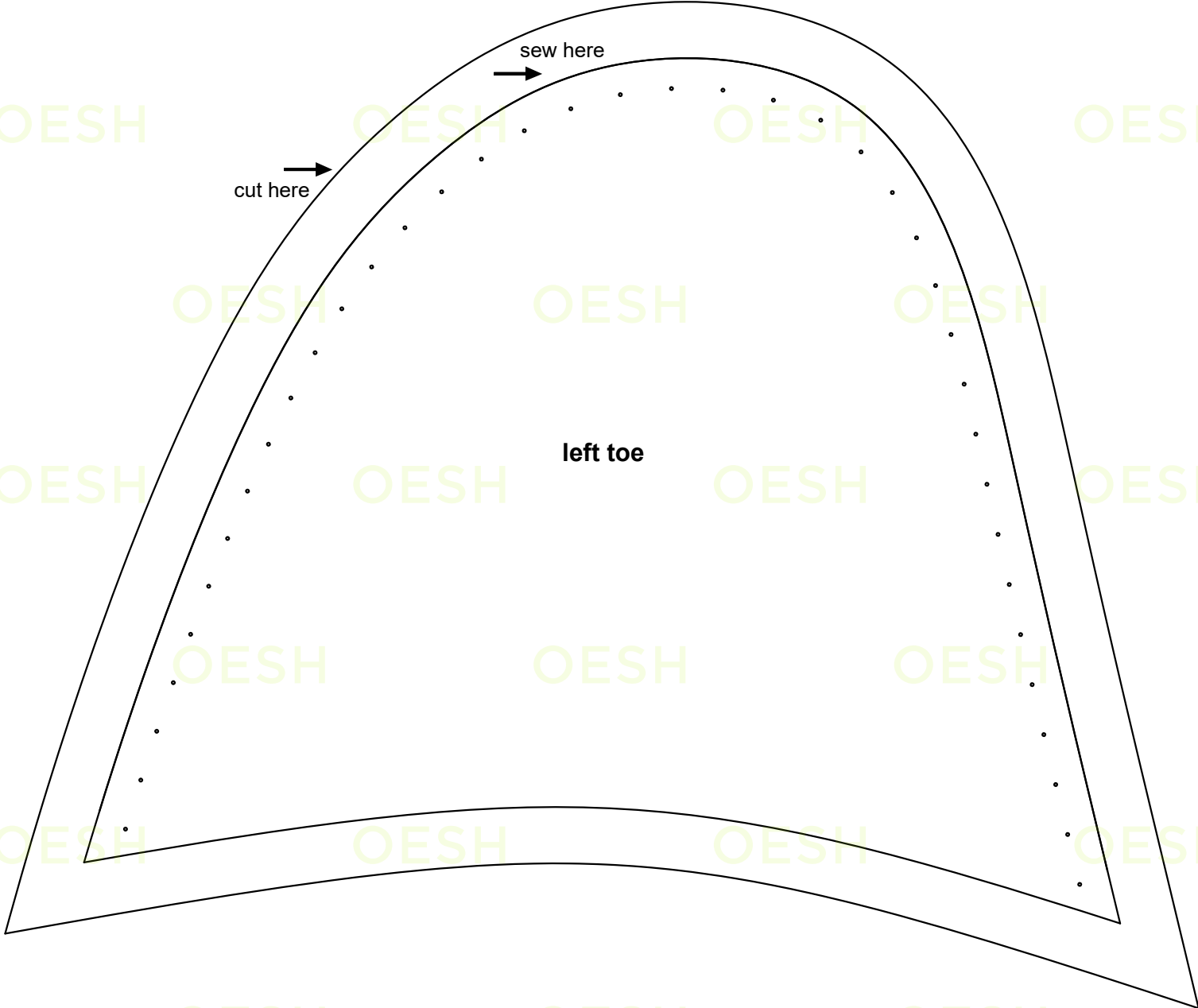

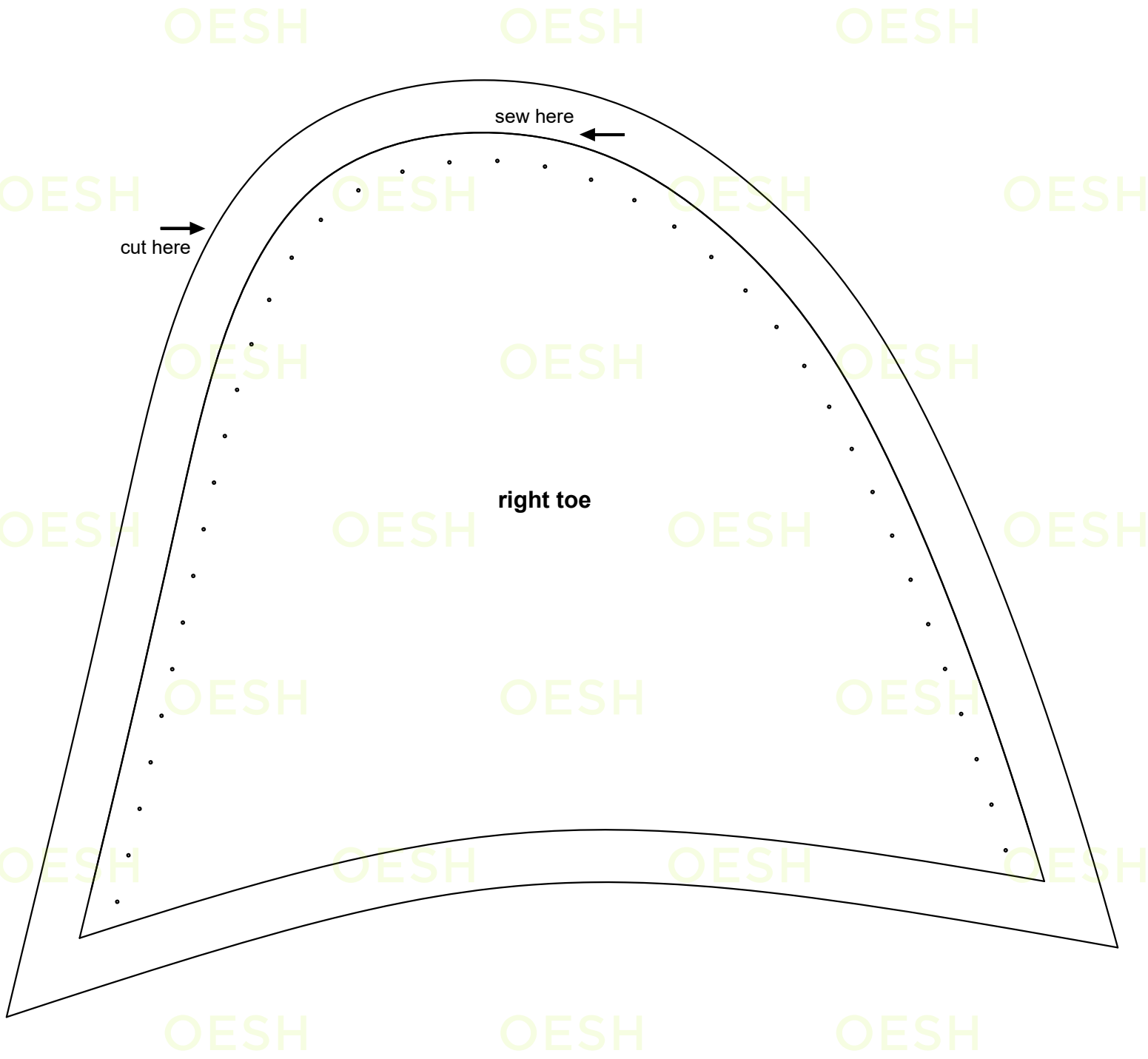

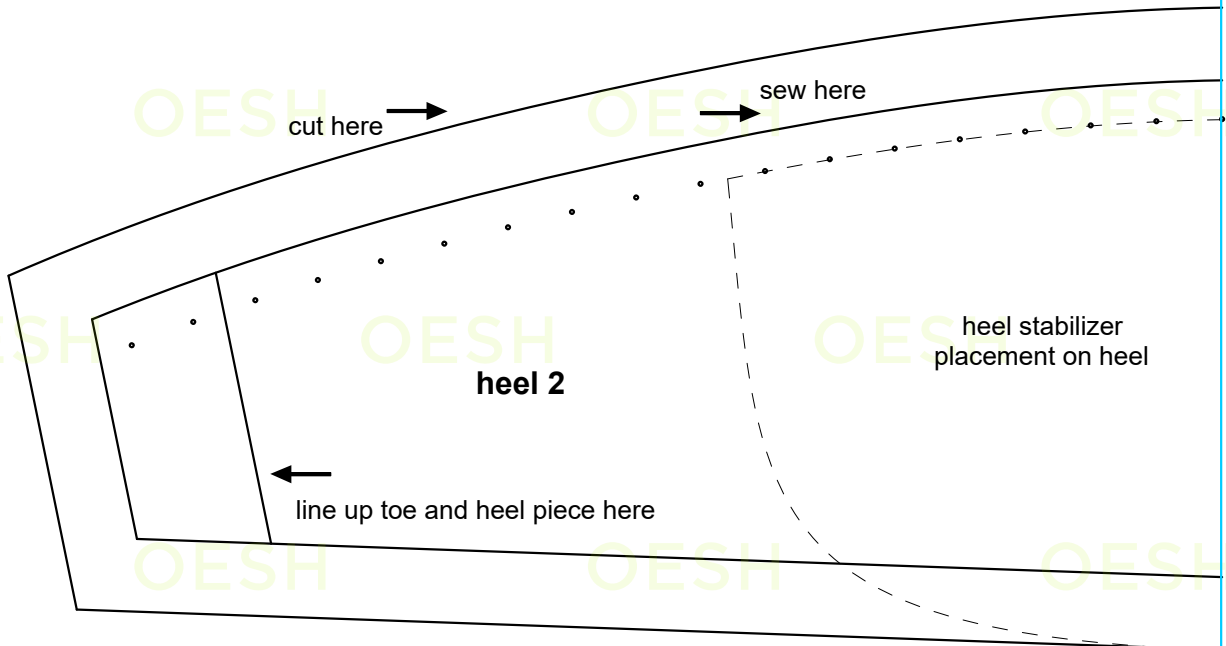
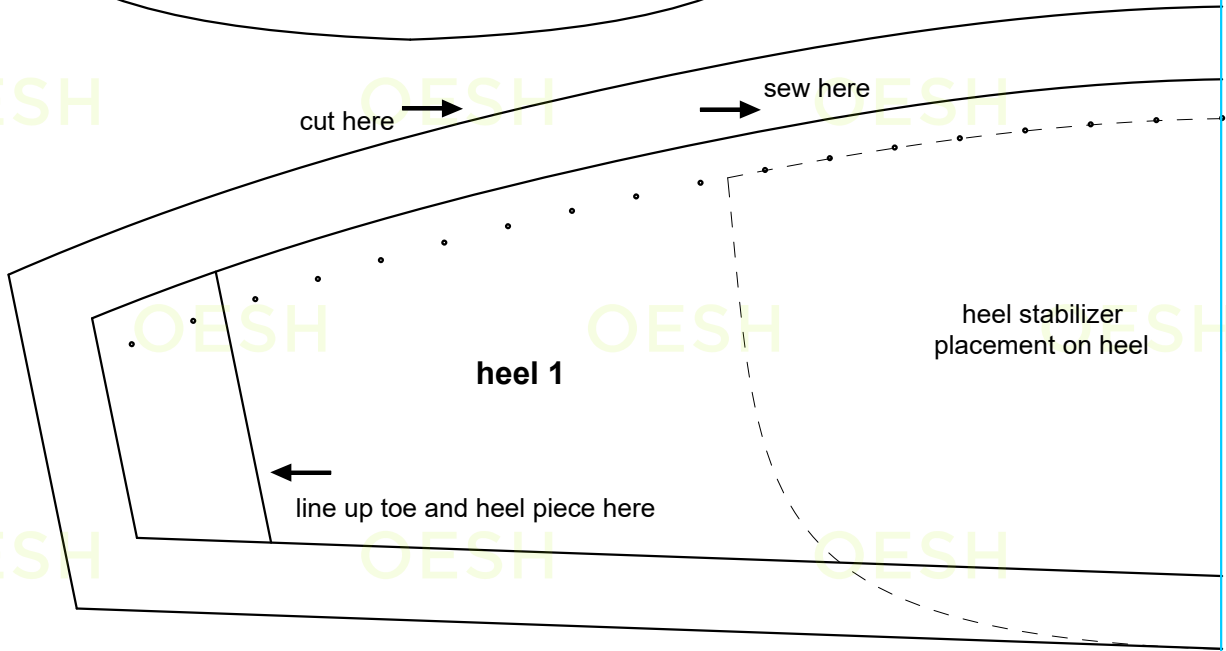
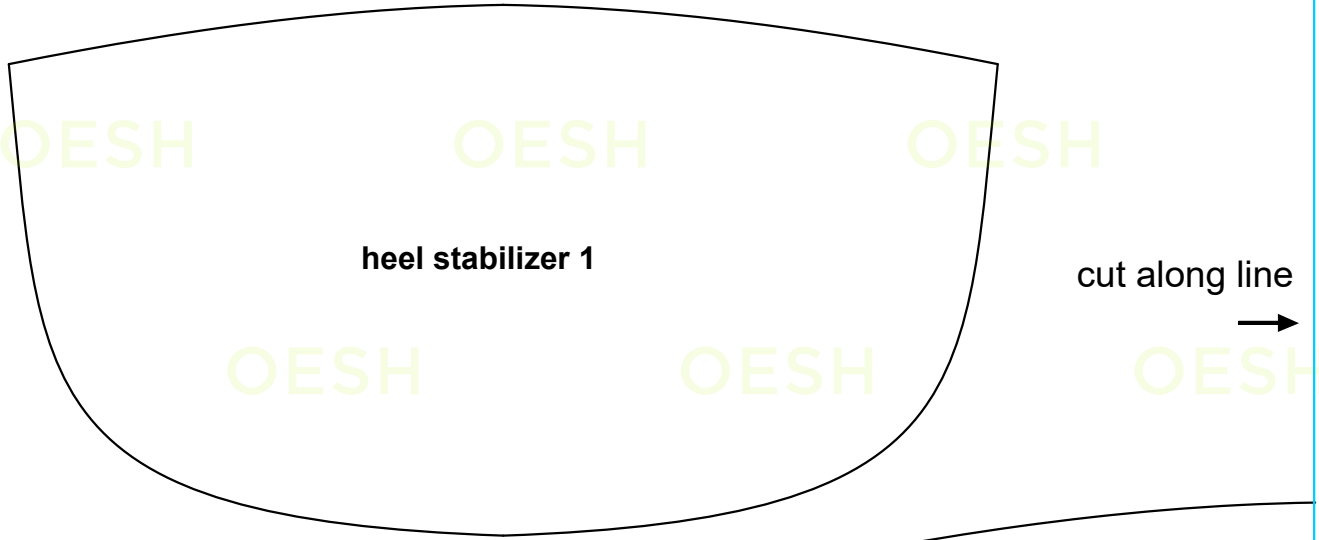

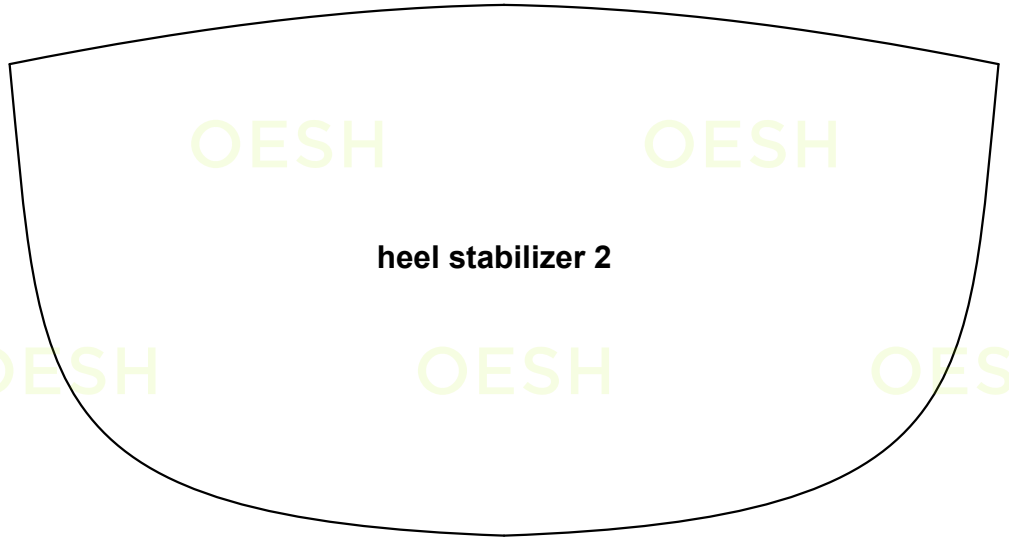

attach pages along line

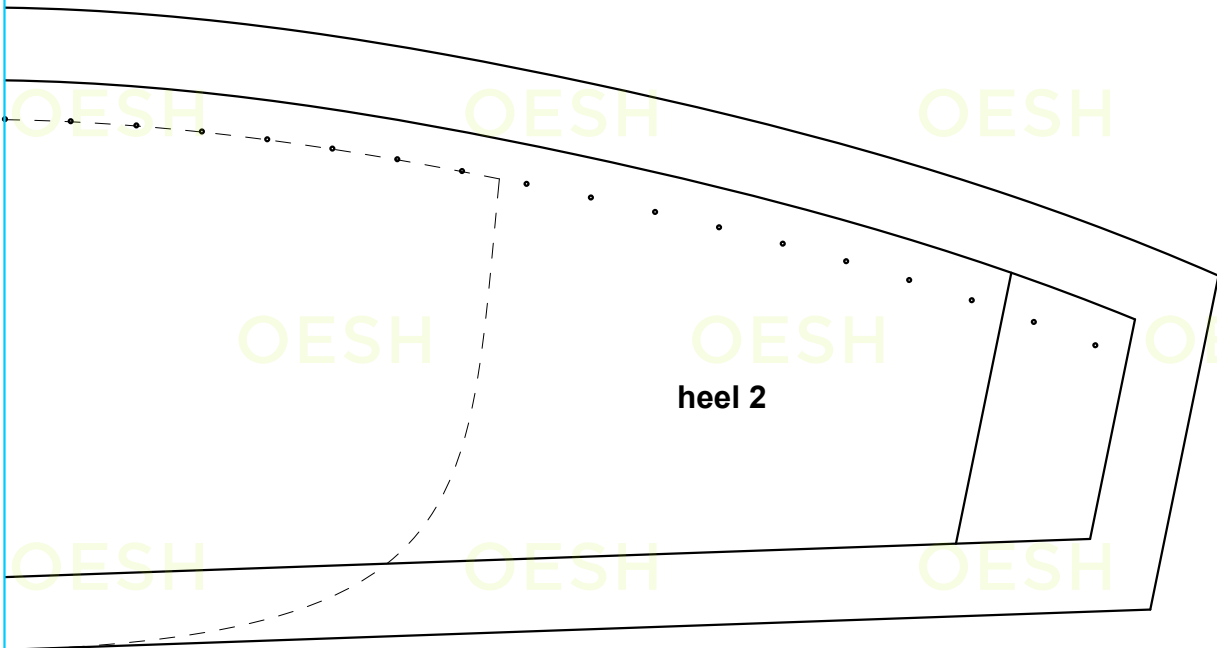
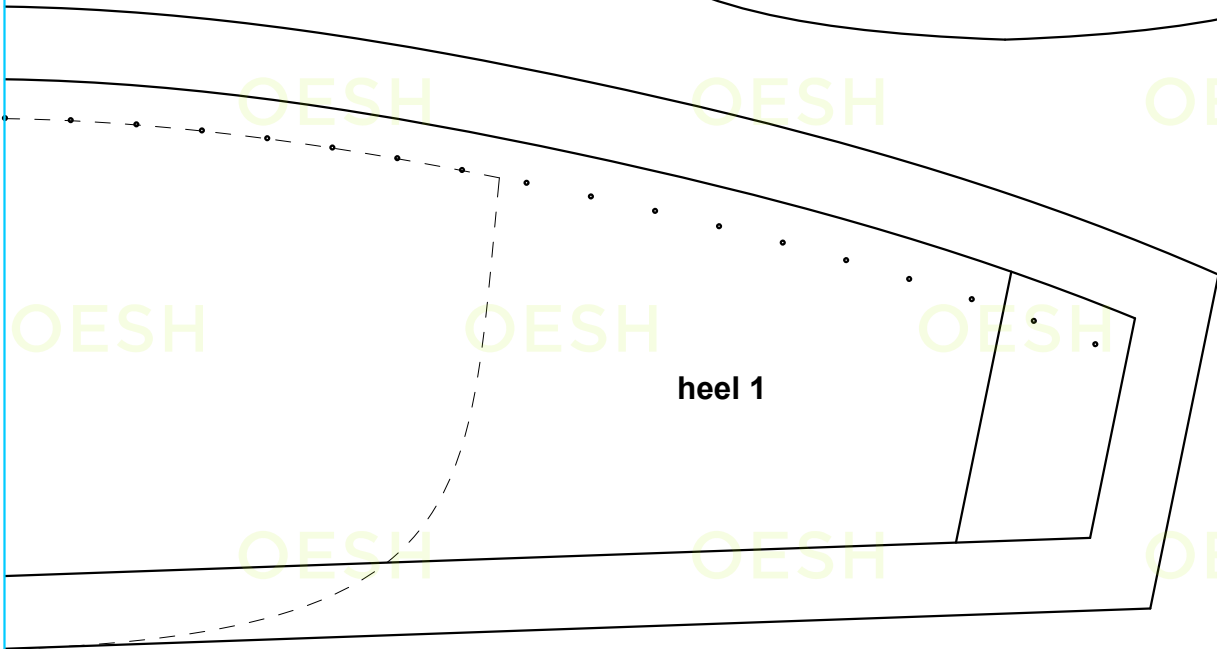

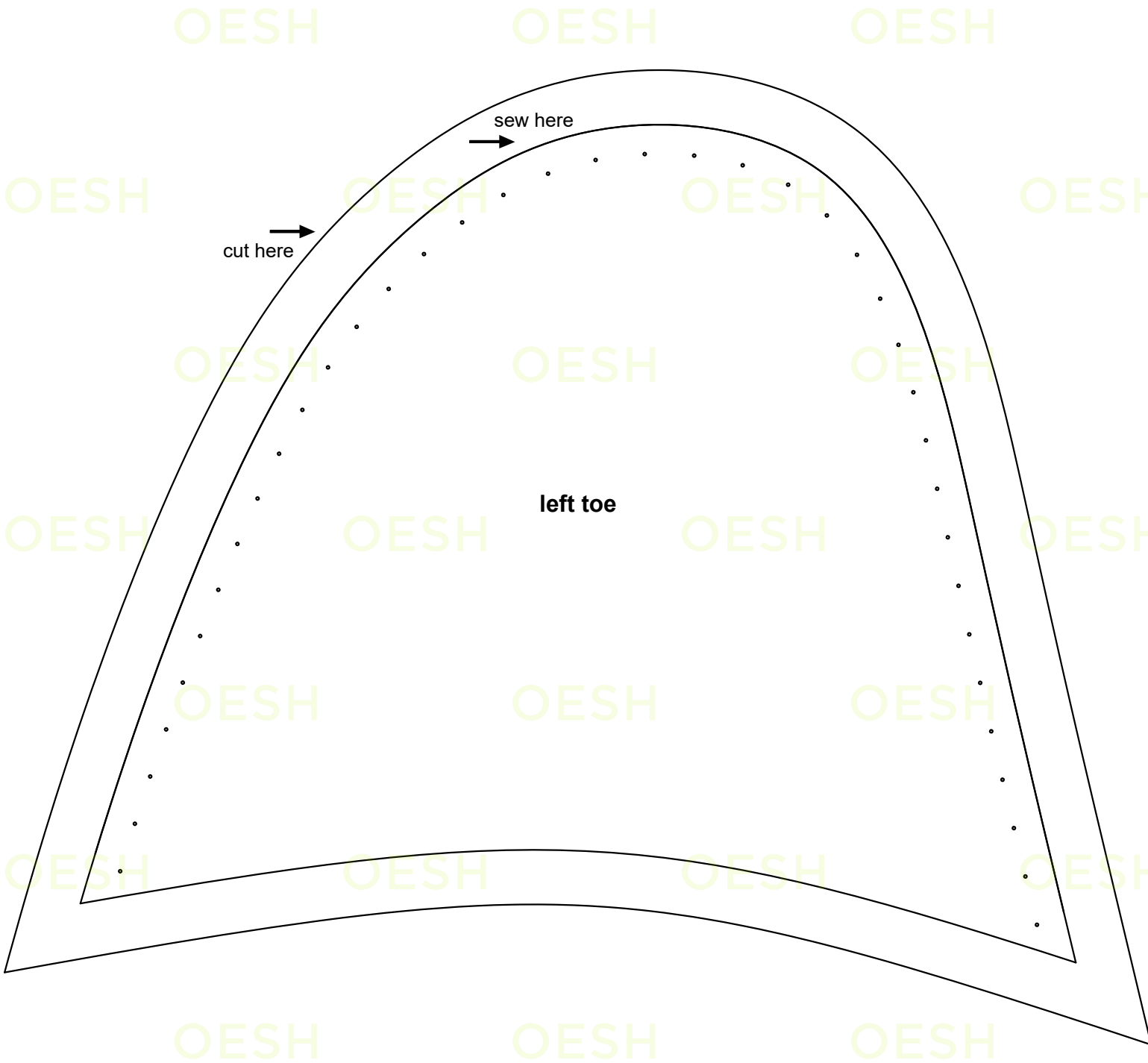

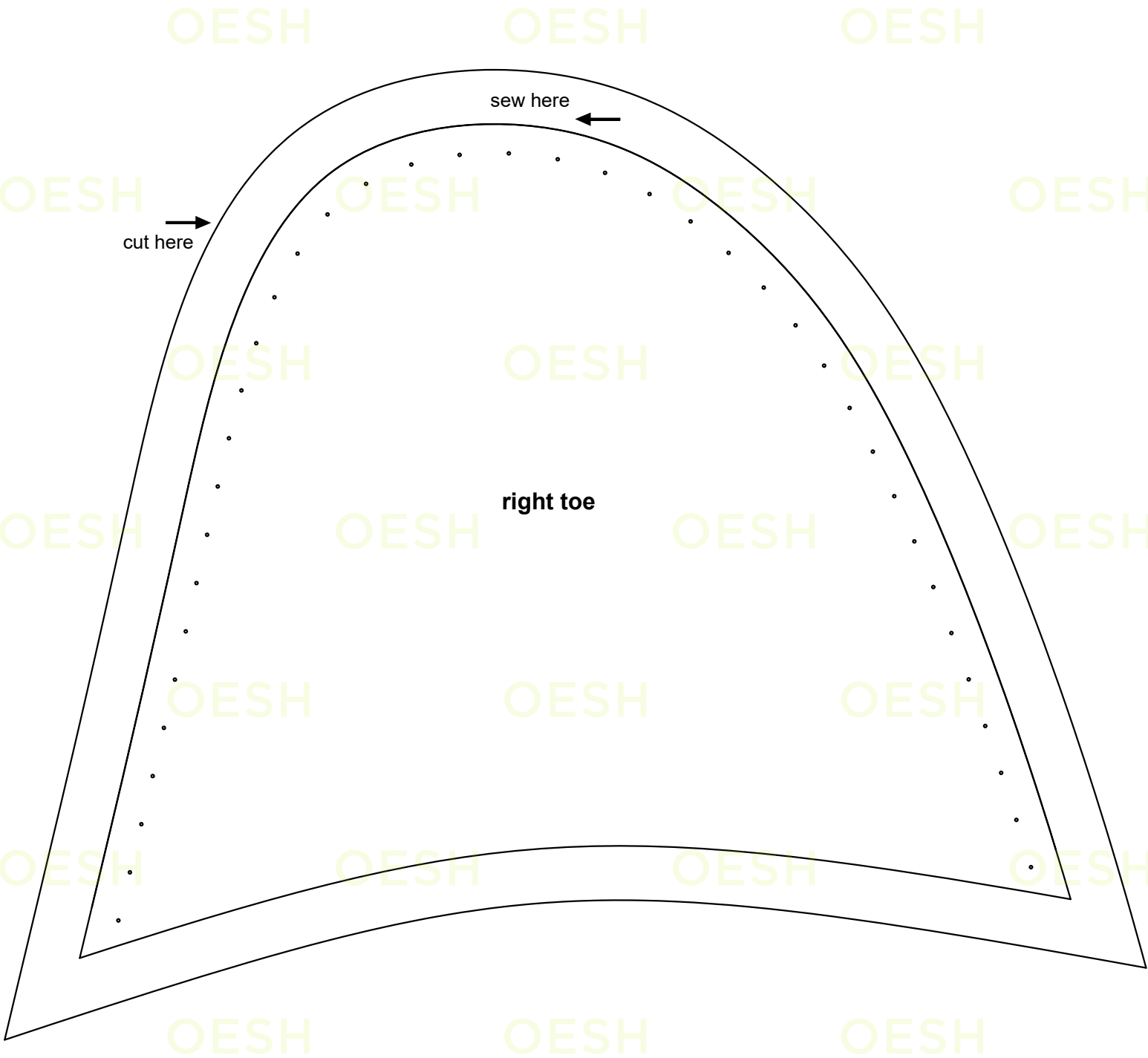

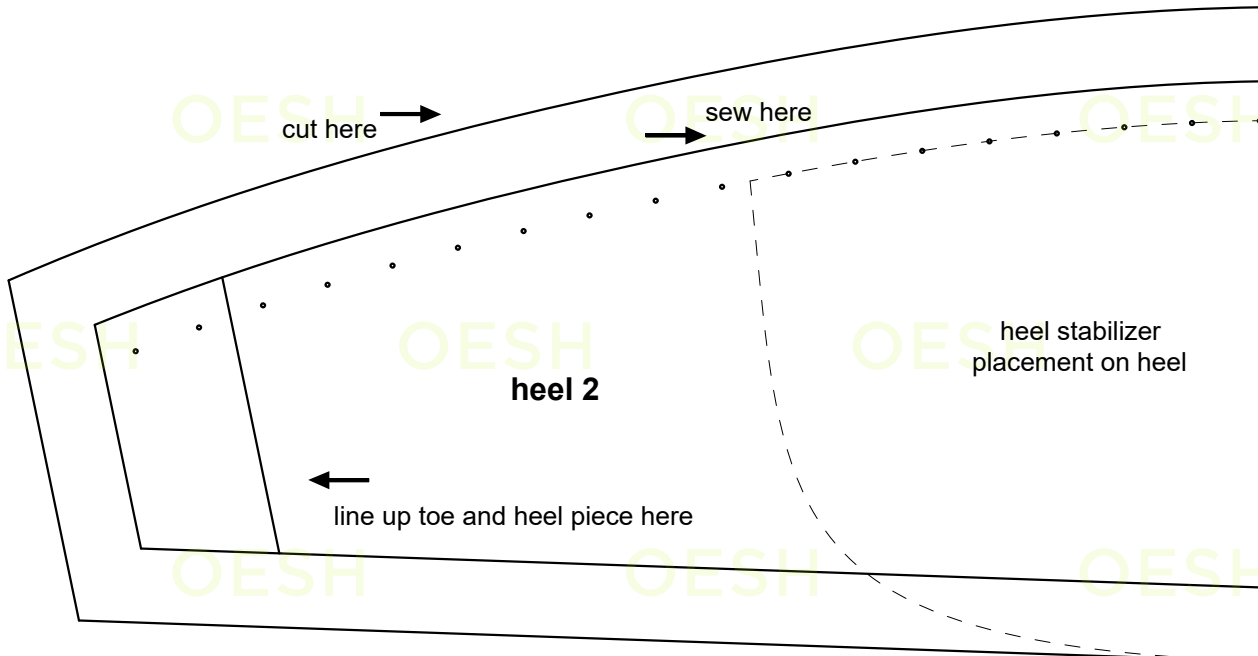
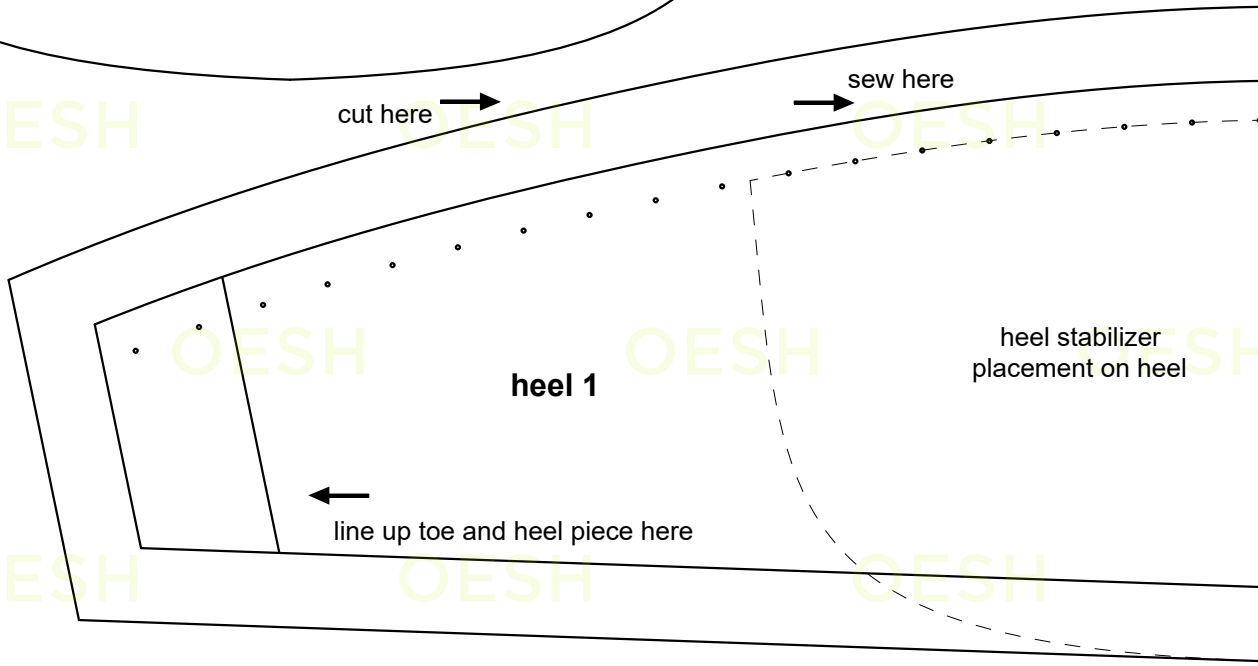
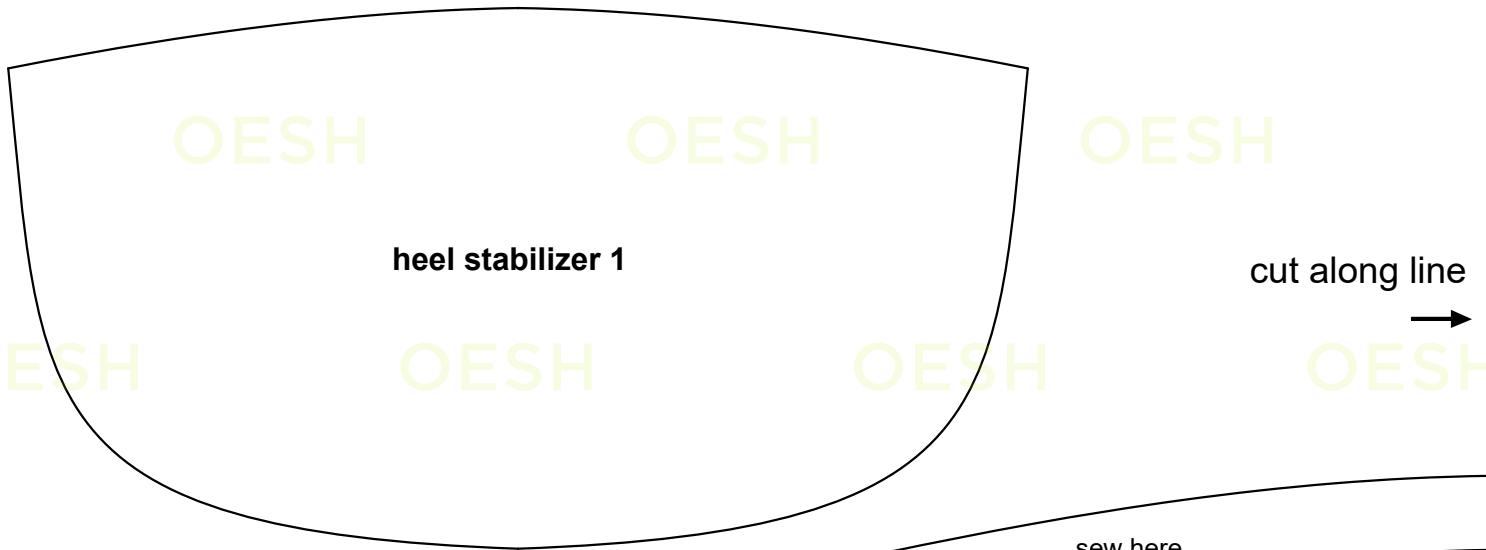

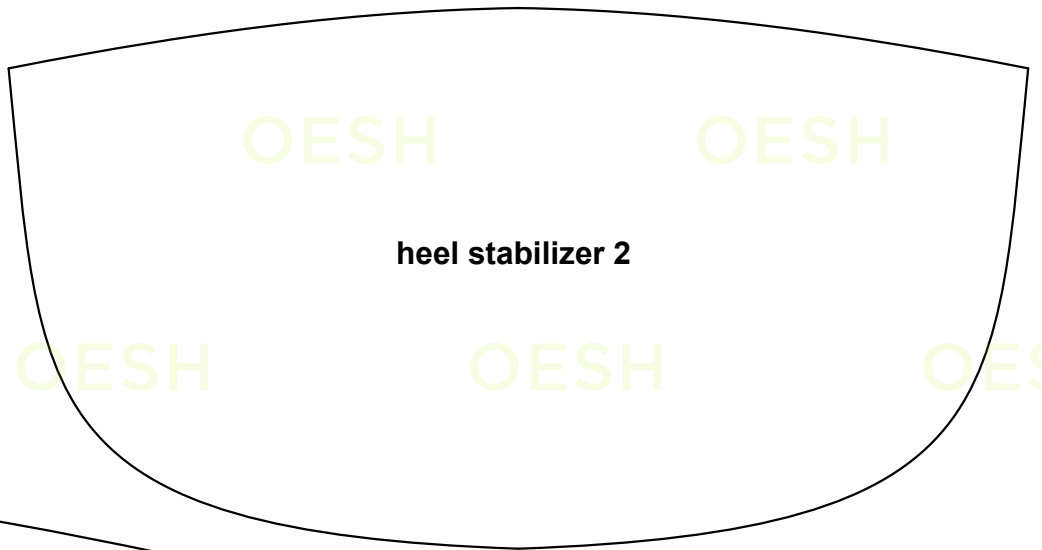

attach pages along line

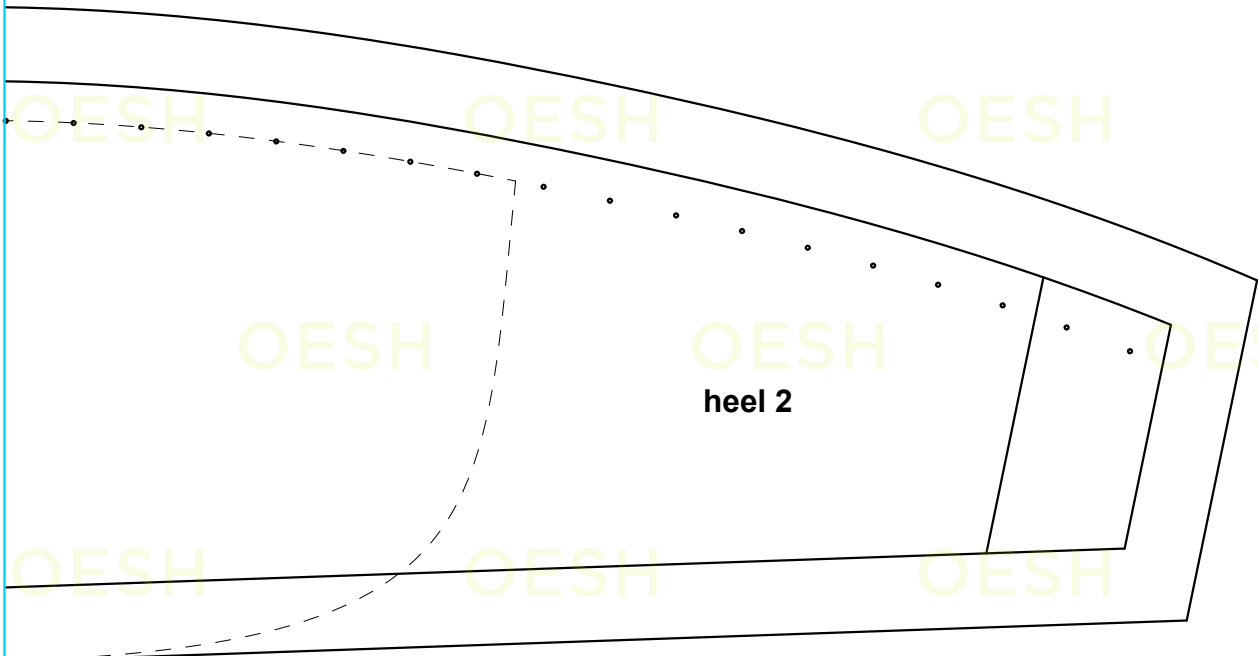
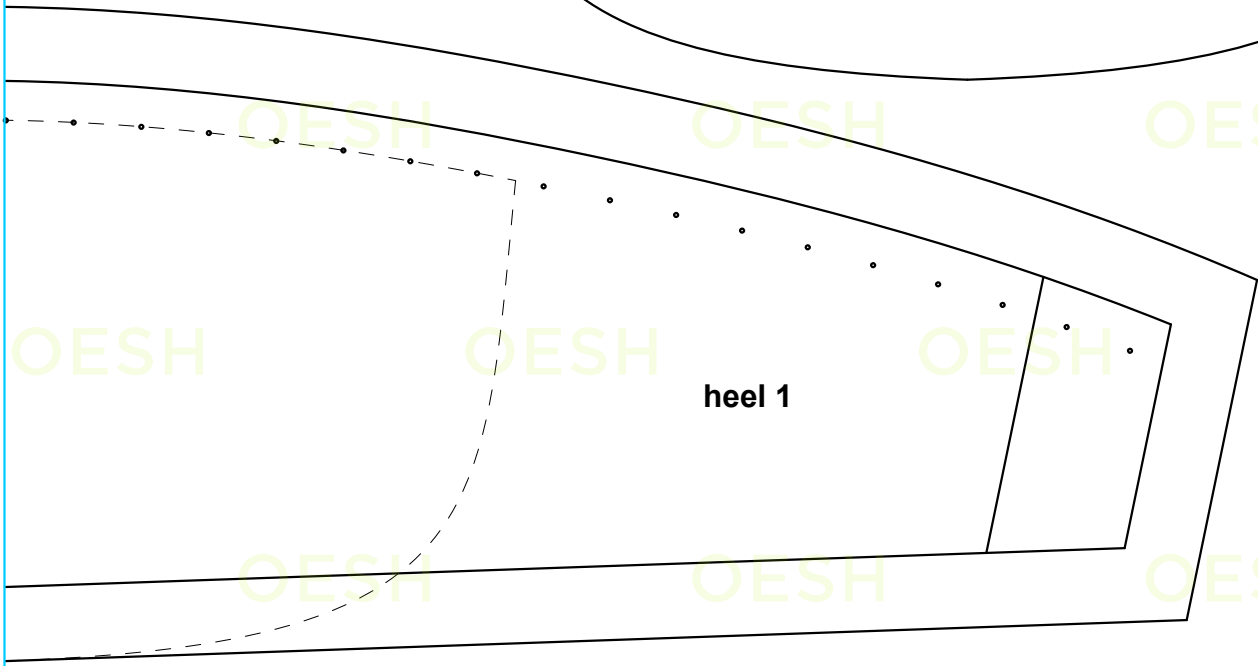

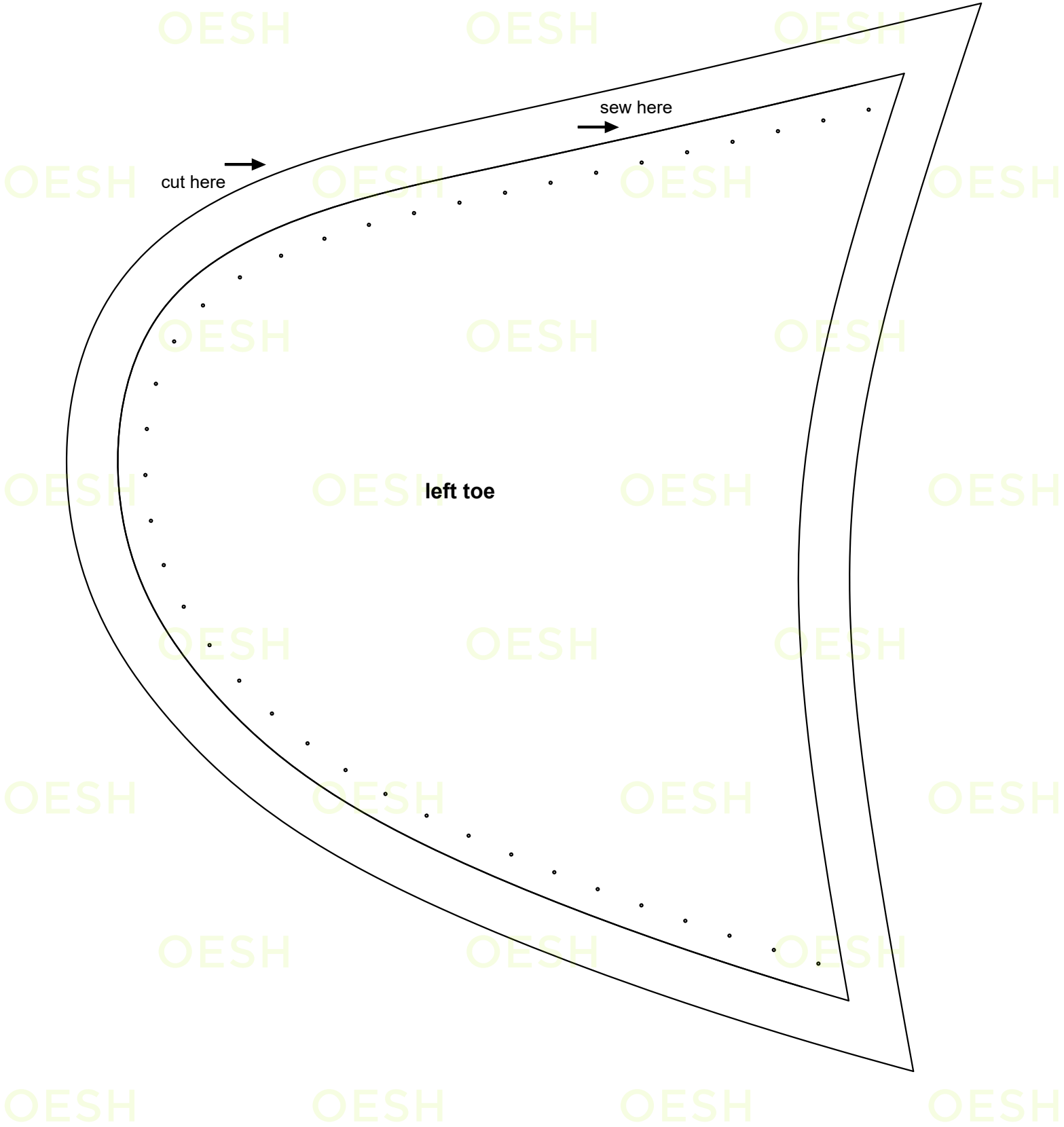

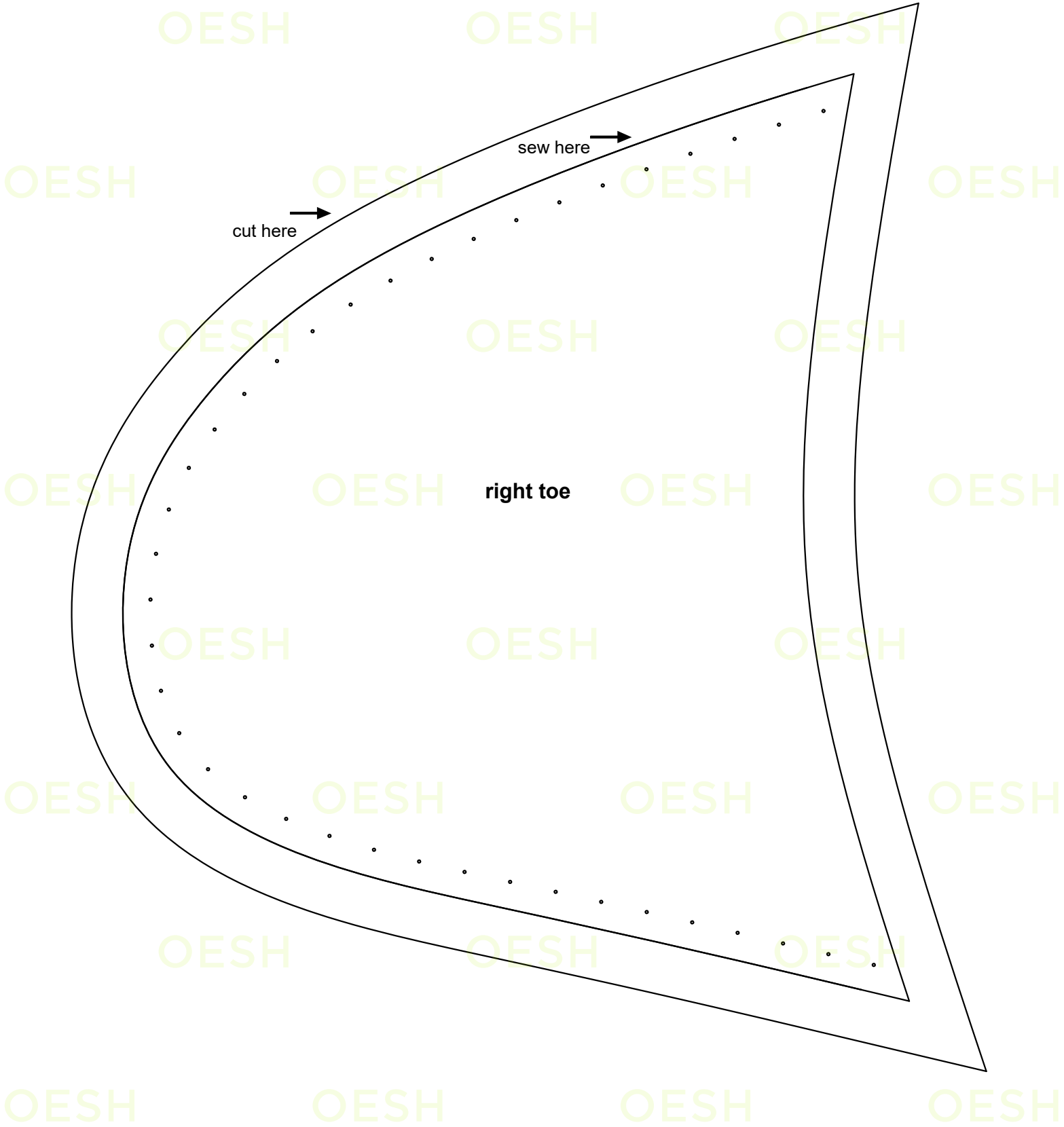

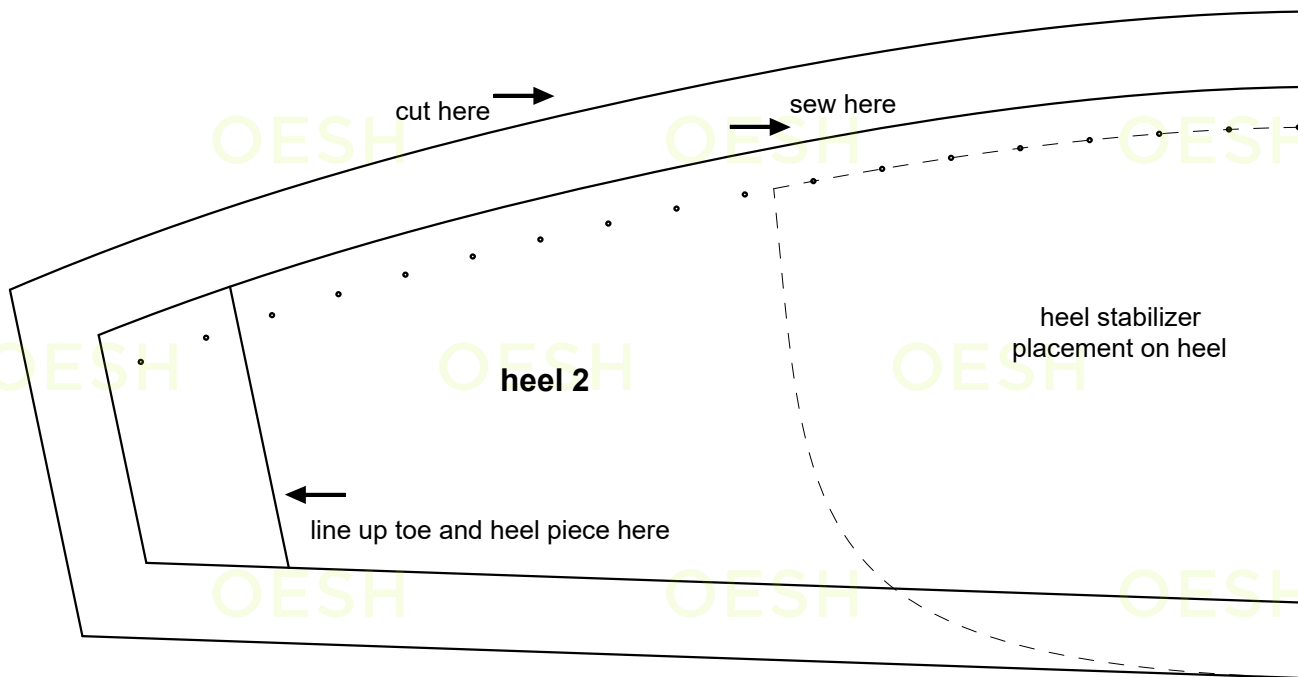
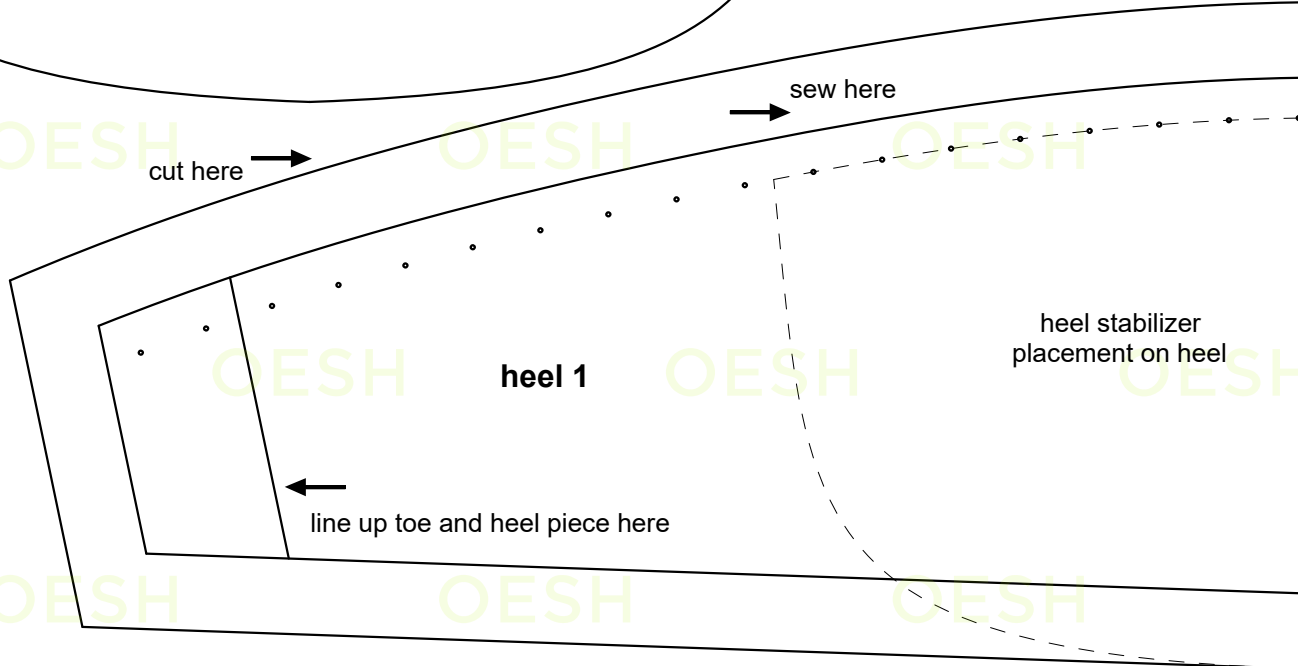
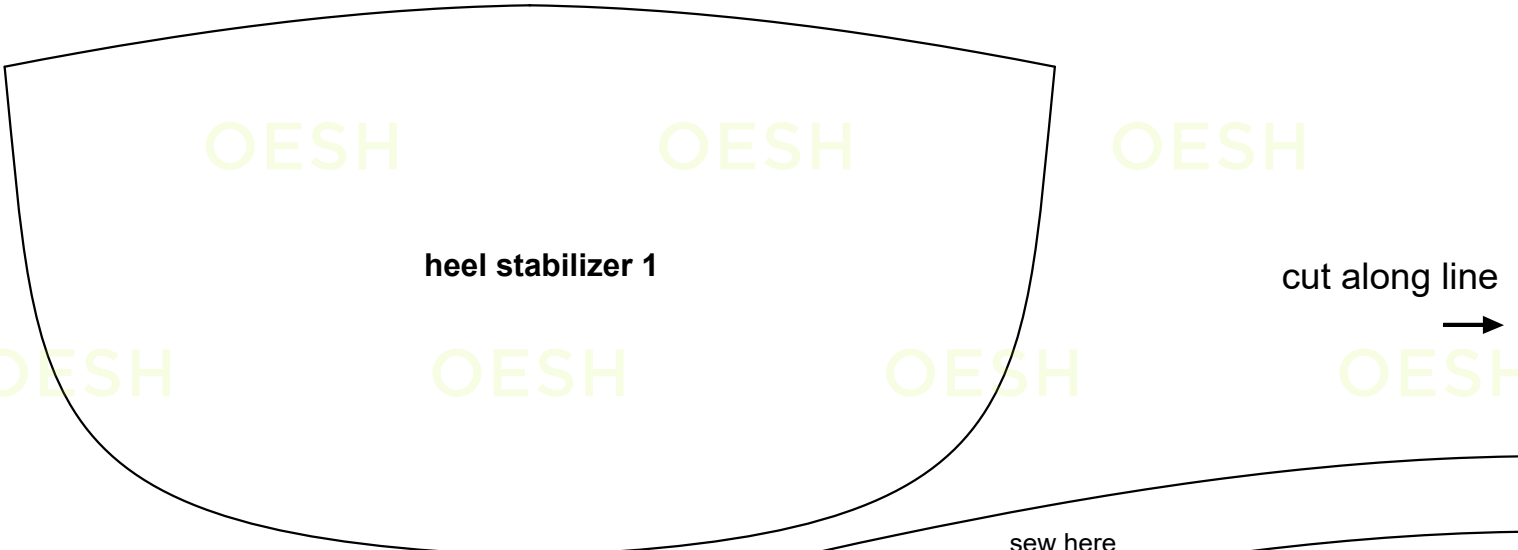

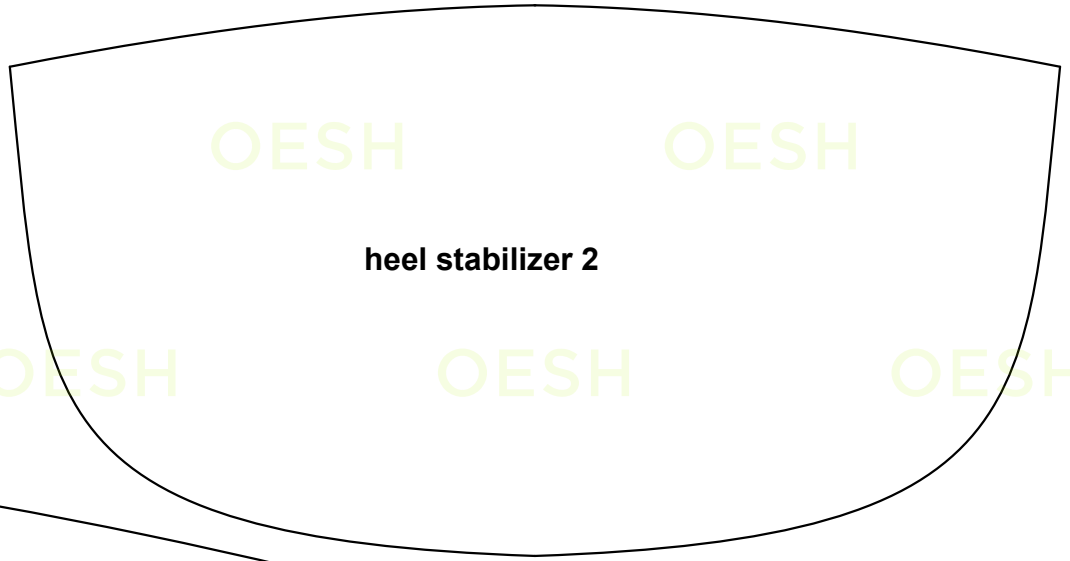

attach pages along line

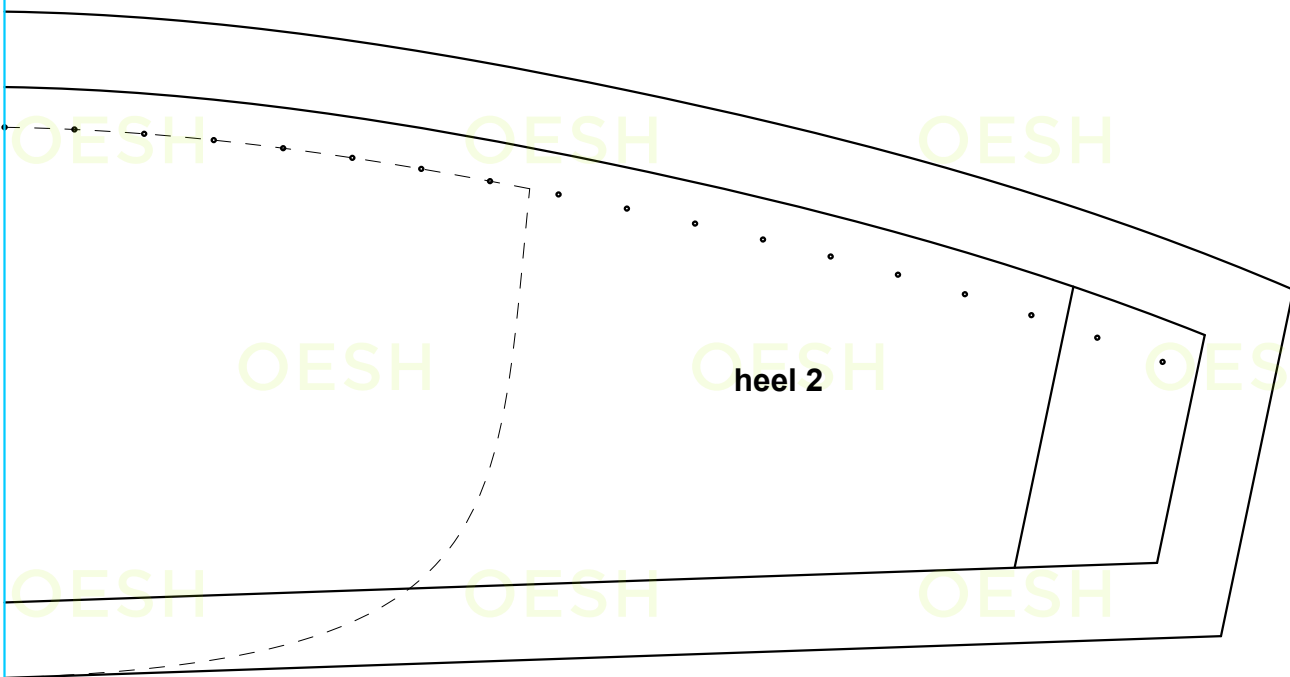
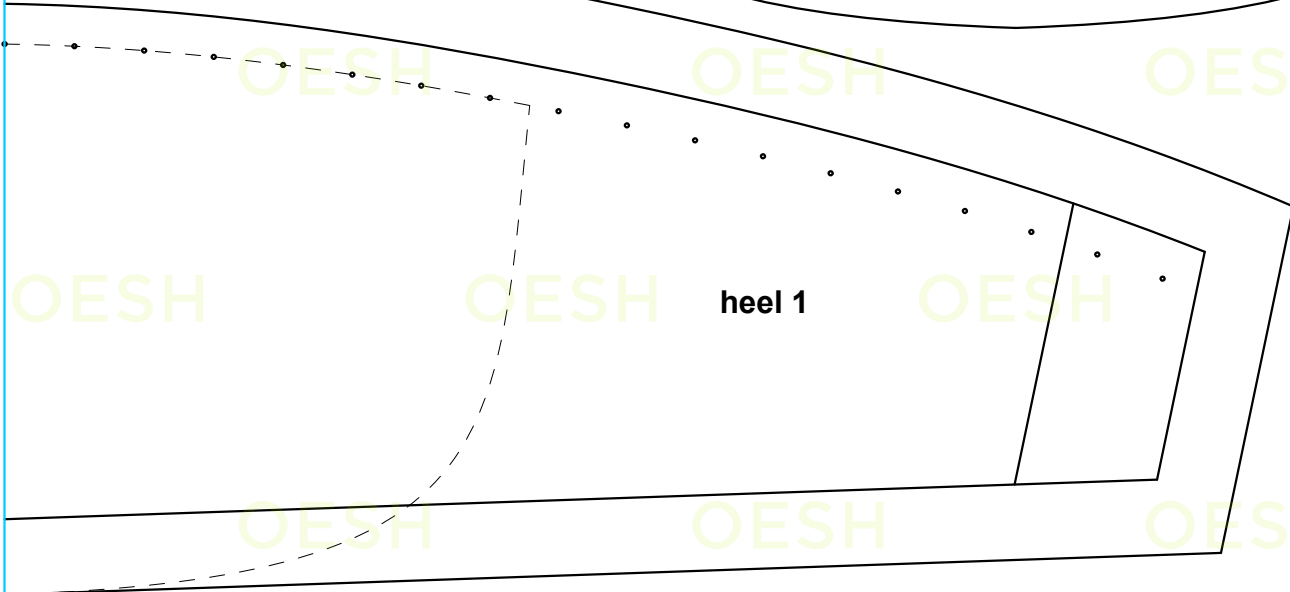

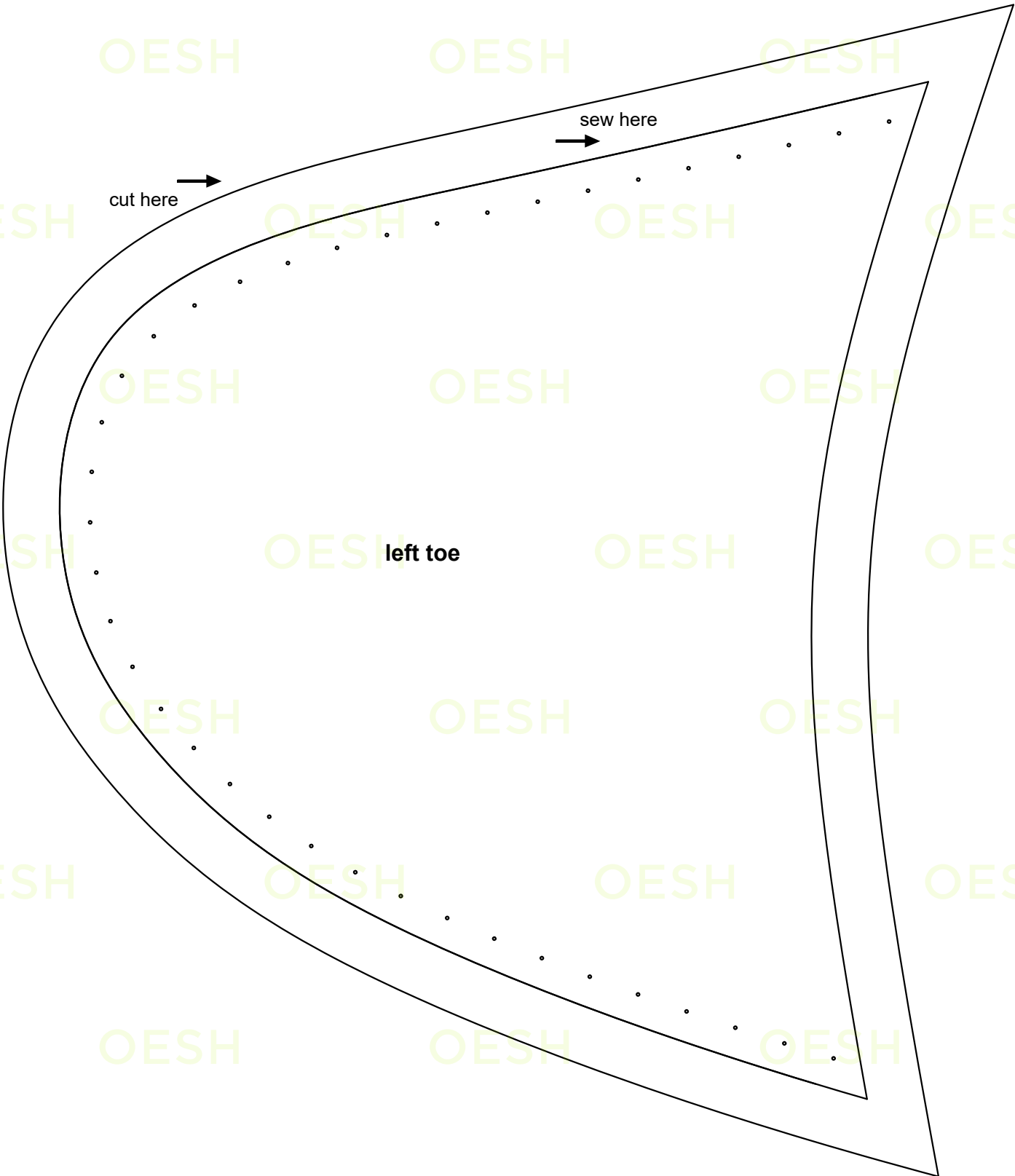

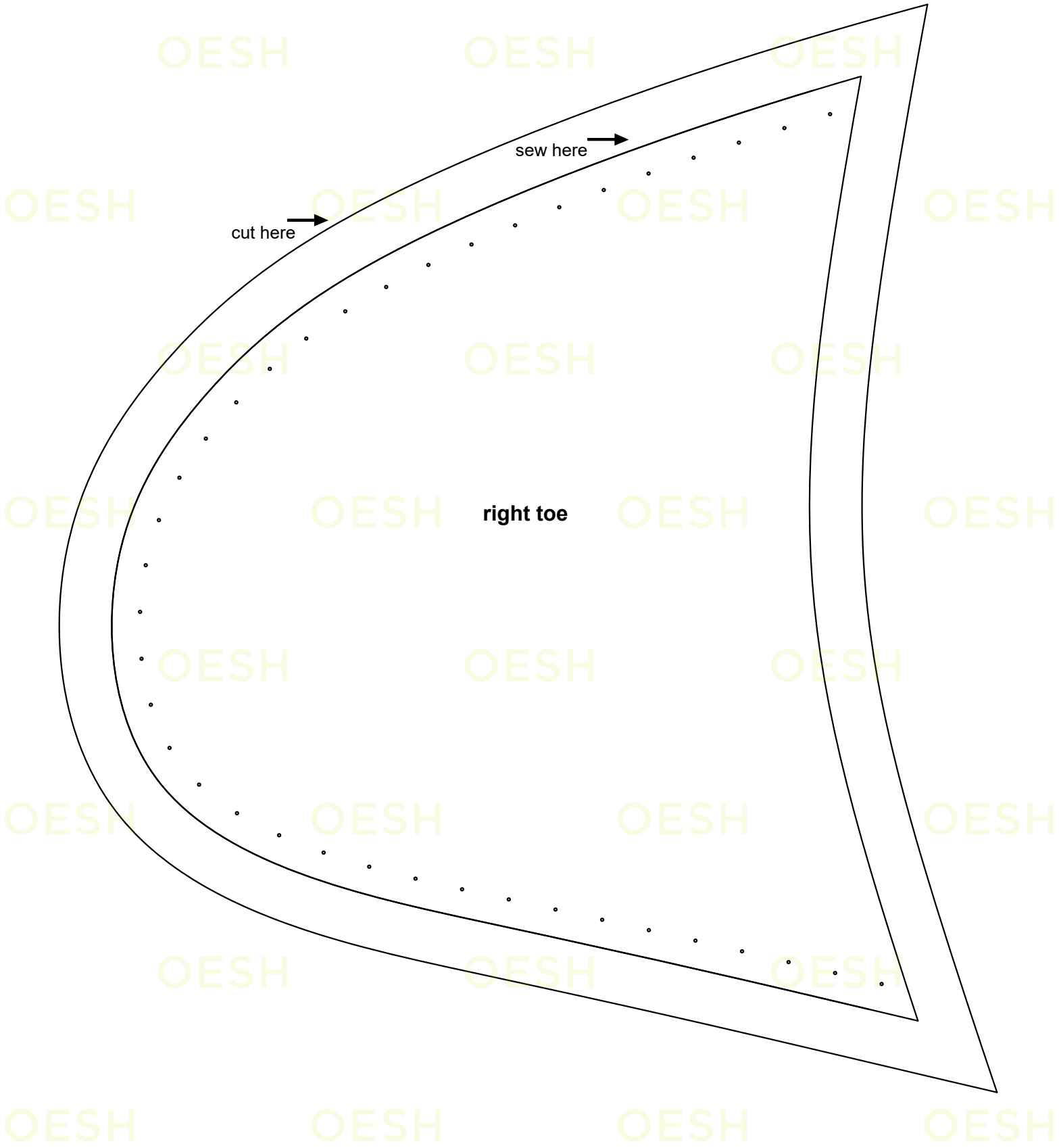

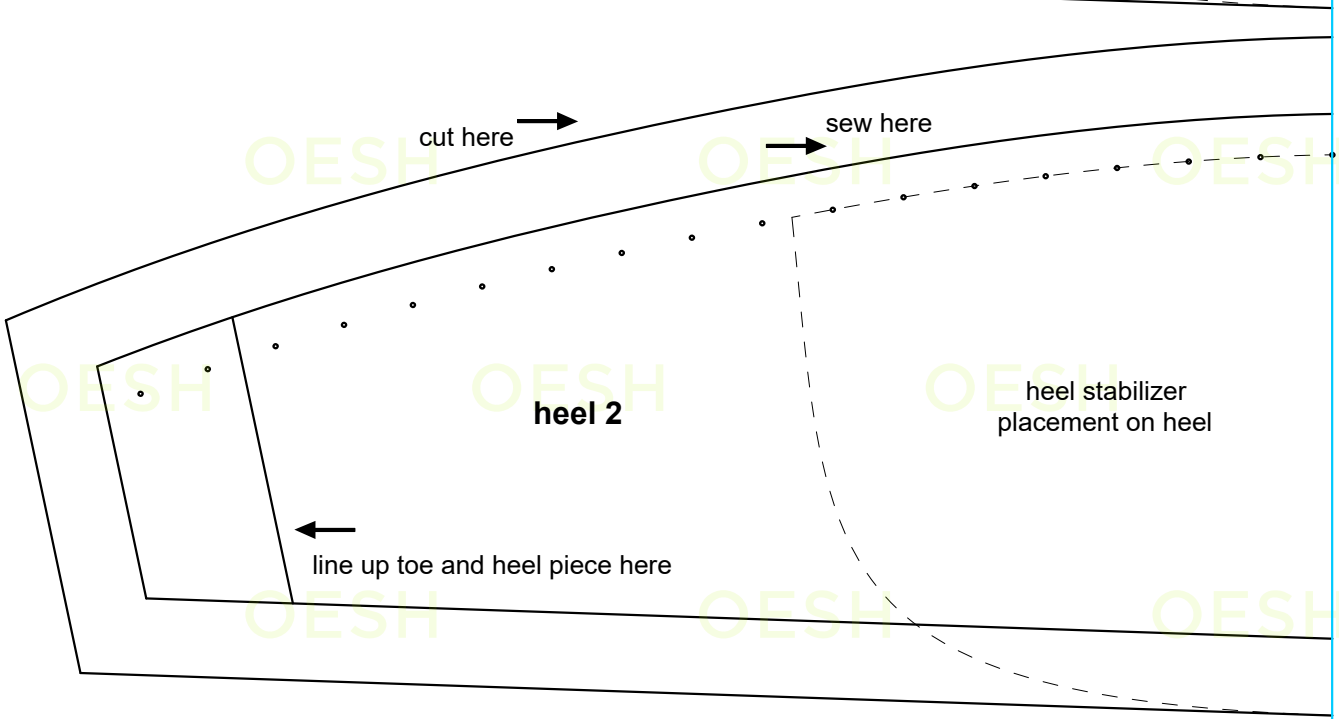
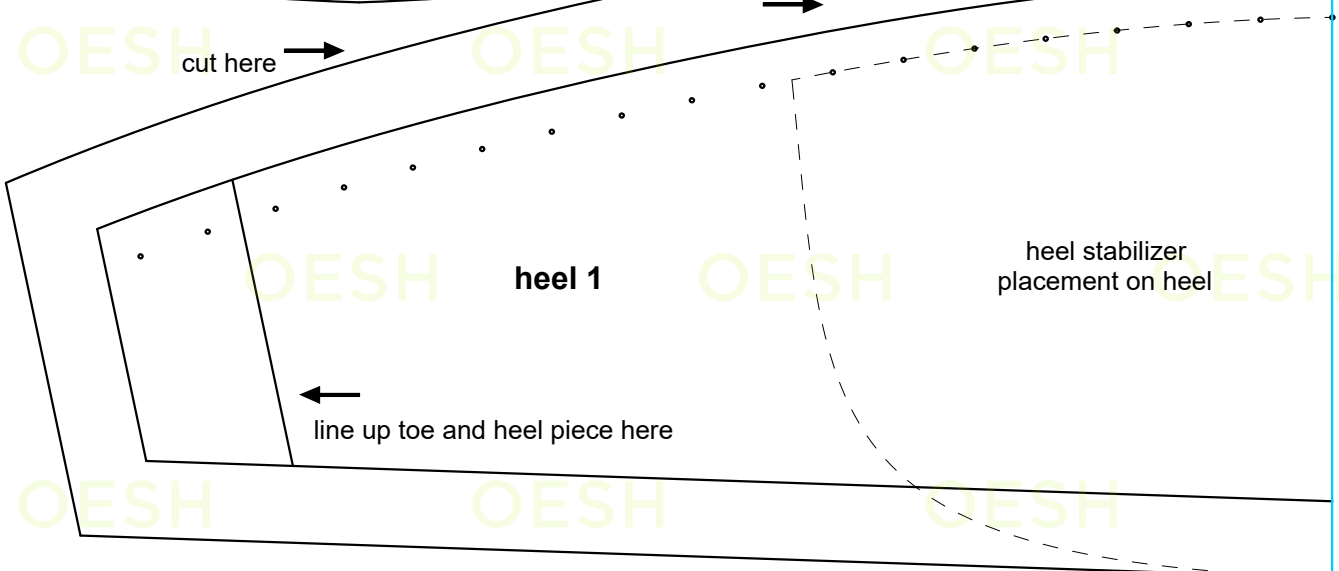
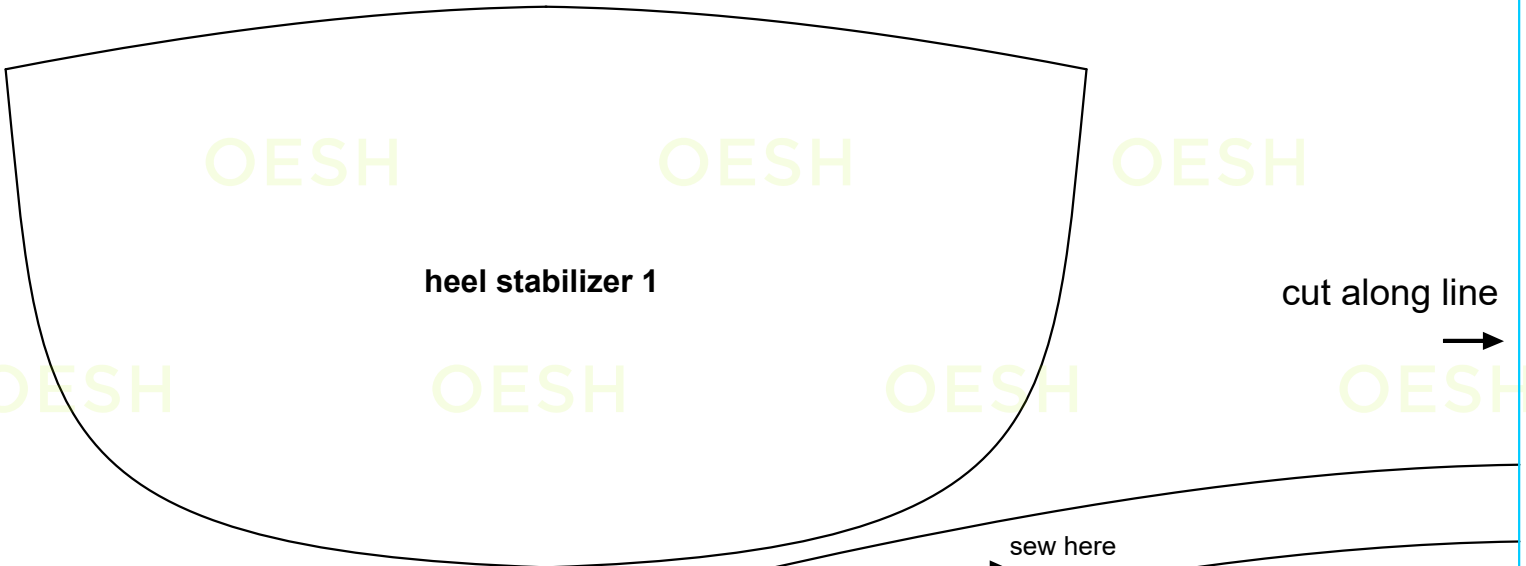

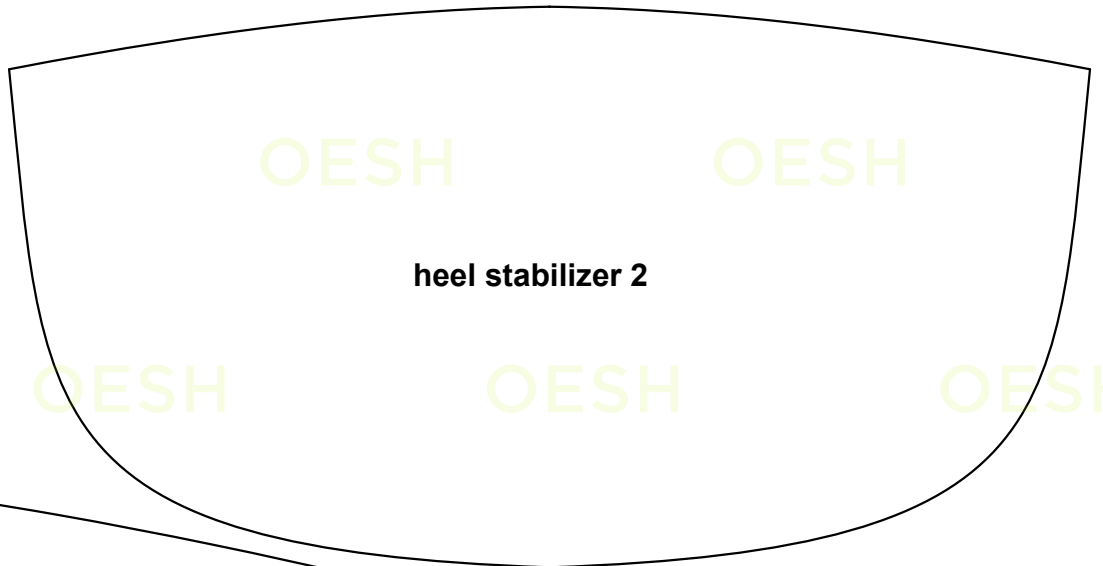

attach pages along line

